

STANLEY®

MASTER CATALOG 2014

STANLEY

MASTER CATALOG 2014

STANLEY®

All rights reserved. Neither this catalog nor its text, illustrations, drawings or any part thereof, may be reproduced, stored in a retrieval system, photocopied, recorded or transmitted in any form, whether electronic or otherwise, without our consent. To the best of our knowledge, all descriptions and illustrations contained in this catalog are correct at the time of print. We cannot, however, be held liable for any inaccuracies of description or illustration and reserve the right to change specifications without notification.
© Stanley Works 2014.

001-012-2013



www.stanleytools.com

STANLEY®

HISTORY TIMELINE



1843

Frederick T. Stanley founded The Stanley Works, originally a bolt and door hardware manufacturing company located in New Britain, Connecticut.

1857

Frederick's cousin, Henry Stanley, founded The Stanley Rule and Level Company.

1899

Stanley Works first patents a ball bearing hinge



1920

The Stanley Works Rule and Level Company merged with The Stanley Works and would go on to become its famous Hand Tools Division.

1930

STANLEY® Access Technologies introduces the first Automatic Door. The Stanley Magic Door was first installed in Pennsylvania Station in New York City.



STANLEY

FatMax®

1999

The Stanley Works launched the STANLEY® FatMax® Tape Rule. The innovation of STANLEY® FatMax® Tapes revolutionized the measuring market with the world's first 1-1/4" wide tape measure delivering 11ft, or 60% longer tape blade standout. The first generation of the STANLEY® FatMax® AntiVibe® hammer is launched, utilizing STANLEY®'s innovative and patented AntiVibe® technology to minimize shock and vibration at impact.

STANLEY®

2013

Stanley Black & Decker introduced a new brand identity for its STANLEY® branded products and businesses, modernizing one of the most recognizable brands in the world. The new brand identity exemplifies the STANLEY® 170-year reputation for innovation, quality and performance. The common core of all of our STANLEY® branded products and businesses is excellence in performance.



STANLEY® commemorates its 50 years of innovation with a series of limited edition 50th anniversary STANLEY® PowerLock® tape measures. Since it was launched in 1963, it is still one of the most popular tape measures in the US and continues to be manufactured in the original plant in New Britain, Connecticut, USA.

1940s

STANLEY®'s fleet of Rollorama coaches carried more than 1,300 sample items to retailers.

1963

STANLEY® Supply & Services started out as Contact East – a small, independent organization representing various manufacturers of capital equipment and services. As electronic packaging miniaturization accelerated, so did the need for specialized tools, supplies and bench top equipment used in the electronics workplace. Finding all these products from one source, however, was a challenge. Recognizing the need for a distributor of these products, the company launched its first catalogue founding Stanley Assembly Technologies, an operating group of The Stanley Works, in the process.

STANLEY®

Hydraulic Tools

1984

In 1984, The Stanley Works purchased HED, Inc., the largest U.S. manufacturer of mounted hydraulic breakers and compactors, and integrated HED's product line, design and manufacturing expertise with the Hydraulic Tools Product Group. Today, STANLEY® Hydraulic Tools is the world's largest handheld hydraulic tool manufacturer and world-wide market leader offering over 150 handheld hydraulic tools and over 30 mounted impact tools.



1992

Jensen Tools is integrated into Contact East to add more than 50 years' experience of being the foremost supplier of tools and tool kits for installation, maintenance, service and repair professionals. The Stanley Works also purchased LaBounty Manufacturing, Inc., the global market leader for mounted, nonimpact attachments serving general contractors, scrap metal recyclers, demolition experts, and heavy construction.

2000

STANLEY® was awarded the Prestigious Golden Hammer Award for New Product Innovation.

2005

STANLEY® Launched the STANLEY® FatMax® Xtreme™ product line, spawning new platforms of professional tools and innovation like the FUBAR® Utility Bar.



2011

STANLEY® Power Tools range was launched in S.E.A to deliver products which are engineered for the trade, offering the ultimate in Power Tools and durability in a range of PowerTools for drilling & grinding on metalworking, woodworking and concrete working applications.

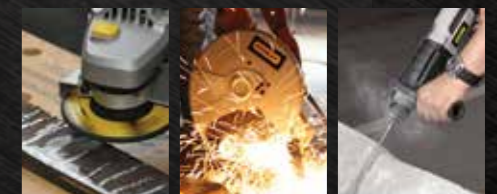

STANLEY®

A NEW STORY BEHIND EVERY TOOL

STANLEY® has been manufacturing high quality tools since 1834, well before Henry Ford's Model T and Orville and Wilbur's fun fly at Kitty Hawk. Ten years later, A.Stanley & Company was founded and began producing folding wooden rules for carpenters and other tradesmen. From those humble beginnings, STANLEY® Tools grew to become today's gold standard by which other hand tools are measured.

In 12 March 2010, STANLEY® completed a merger with the Black & Decker Corporation. Black & Decker is a leading global manufacturer and marketer of power tools and accessories, hardware and home improvement products, and technology-based (engineered) fastening systems. With the merger, STANLEY® changed its name to Stanley Black & Decker, Inc. The combination would bring together two companies whose product lines are complementary. STANLEY®, a diversified industrial company that sells hand tools and construction equipment, while Black & Decker is known for its power tools.

The organization's purpose has then burgeoned, leading to embrace a refined approach in the way the organization handles its everyday operations and interactions. Looking to communicate the breadth of its offering and establish a unified brand, STANLEY® introduced a new logo and identity, modernizing it as one of the most recognizable brands in the world. The new brand identity exemplifies STANLEY®'s 170-year reputation for innovation, quality and performance. This change is the result of a rebranding effort designed to mirror the growth and transformation of the STANLEY® brand throughout the years.

Today, STANLEY® is proud of its reputation for excellence. STANLEY® is dedicated to continually test, design and improve its products to ensure quality and maximum function. The product offerings range from measuring & layout tools, to cutting & fastening tools, and spans across power tools and accessories. So regardless of whether you're a professional contractor, a do-it-yourselfer- you can always trust the quality and accuracy of STANLEY® tools, as people have for nearly 8 generations.



CONTENTS

Section 1 : Measuring & Layout Tools	02
Section 2 : Laser Measuring System	20
Section 3 : Cutting And Holding Tools	36
Section 4 : Fastening Tools	68
Section 5 : Striking And Stuck Tools	88
Section 6 : Illumination Tools	104
Section 7 : Painting And Finishing Tools	108
Section 8 : Mechanic Tools	126
Section 9 : Tools Storage	174
Section 10 : Power Cleaning Tools	188
Section 11 : Power Tools	196
Section 12 : Power Tool Accessories	212
Product Index	218

1 MEASURING AND LAYOUT TOOLS

ACCURACY, DEPENDABILITY & DURABILITY

STANLEY®'s measuring innovation has established STANLEY® as a leading worldwide Tape Rule manufacturer. Our expanded line builds on this great heritage. For example, our new FatMax® Xtreme™ Tape Rules features 13" of blade standout, the longest in the world. We've also improved on classics by adding BladeArmor™ Coating to FatMax® and FatMax® Xtreme™ Tape Rules to extend the life of the blade. And that's only the beginning. Take a look at our tape line and see why after years of innovation, STANLEY®'s Tape quality and durability are unmatched.

WHY STANLEY® SHORT TAPES?

- 1 Blade Stand Out**
 - 1-1/4" Wide Tape Rule Blade - 40% Longer Standout
 - Selective Cross-Curve Blade -10-15% Longer Standout
 - Multi-Catch End-Hook -Top, bottom, side-side catch utility
- 2 Product Durability**
 - BladeArmor – 2x Longer Life
 - Multi-Layer Blade Armor – Blade Life
 - Chemically Bonded Tape Case Elastomer grip – Bi-Mat Grips
- 3 Compact Case / Longer Blade Length**
 - 1-1/4" Wide Spring & Micro-Hub - 10% Smaller case
 - Hi-Vis Mylar – Easy to read in low lighting (patent pending)
 - Bi-Material Wear Plate – 500x Longer Life
 - Hook Bend Protection – Extends End-hook Life
 - Bi-Material Slide Lock – Crush Proof

- 1 Blade durability: stronger, less/ no breakage**
 - New "fiber" co-extrusion process
 - 3/4" Wide Blade
 - 50% more Reinforcing strands (+5x)
 - Low Temp "PVC" (+15 - 10c)
 - BladeArmor End Reinforcement (+2x)
- 2 Blade Abrasion resistance: print longevity**
 - Extruded over-coat Clear PVC (+500%)
- 3 Retraction Speed: Fast**
 - Gear Drive 3:1



ACCURACY

- When a level is placed on a perfectly level surface, the bubble within the vial is equivalent between the rings
- The accuracy of a level is the measure of maximum lift, over 1 Meter, to bring the bubble dead centre on a perfectly flat and level surface
- Solid Block vials have an Accuracy of 0.5"/inch
- 360° Vials have Accuracy no better than 1.5"/inch

TYPES OF LEVELS

BOX

- Magnetic
- Non-Magnetic

I-Beam

- Magnetic
- Non-Magnetic

TORPEDO

- Magnetic



For half a decade, STANLEY® has stayed true to the iconic image of the PowerLock® Tape Rule, improving only on its performance and durability. Furthermore, STANLEY® has maintained the heritage of manufacturing tapes in New Britain, CT, USA*. This tape design is a dedication to the original PowerLock®, brandishing the same design and markings of the first PowerLock® Tapes manufactured in 1963. Since its launch 50 years ago, it remains one of the best selling tapes in the world. Each PowerLock® Tape features a sliding lock, holding the blade in place, a rigid 7 feet standout Mylar® protective blade coating for durability and a Tru-Zero™ end hook for accurate measurements. Get your 50th Anniversary PowerLock Tape Limited Edition Today!

*Manufactured with global materials.



MEASURING TAPE SELECTION GUIDE

SHORT TAPES	STANDOUT	TAPE WIDTH	CASE MATERIAL	CASE COLOR	LENGTH	
					METRIC	IMPERIAL
RubberGrip Tape Rule		1/2"	ABS/Rubber	Yellow/Black	3m, 3.5m, 5m	-
Global Tape Rule		1/2", 3/4", 1"	ABS	Yellow	3m, 5m, 8m	10', 16', 26'
Tylon Tape Rule		1"	ABS/Rubber	Yellow/Black	5m, 8m	16', 26'
LeverLock Tape Rule		1/2", 3/4", 1"	ABS	Yellow/Black	3m, 5m, 8m	10', 16', 26'
PowerLock Tape Rule	8'	1/2", 3/4", 1"	ABS Chromed	Chrome	3m, 3.5m, 5m, 8m, 10m	10', 12', 16', 26', 33'
FatMax Tape Rule	11'	3/4", 1", 1-1/4"	ABS/Rubber	Yellow/Black	5m, 8m, 10m	16', 26', 33'
FatMax Xtreme Tape Rule	13'	1-1/4"	ABS Chromed	Yellow/Black	5m, 8m, 10m	-

LONG TAPES	TYPE	TAPE WIDTH	CASE MATERIAL	CASE COLOR	LENGTH	
					METRIC	IMPERIAL
Fiberglass Long Tape	Open Reel	1/2"	ABS/Rubber	Yellow/Black	30m, 60m	100', 200'
	Closed Reel	1/2"	ABS	Yellow/Black	10m, 15m, 20m, 30m, 50m	50', 100', 165'
Stainless Steel Long Tape	Closed Case	3/8"	ABS	Yellow/Black	15m, 20m, 30m	50', 100'

New STANLEY® Global Tapes

NEW



30-456N

- Tylon-coated blade withstands abrasion
- High-impact ABS case for durability
- 16" and 19.2" stud center markings simplify framing jobs
- Corrosion-resistant Tru-zero end hook for accurate measurements

SKU#	BLADE LENGTH		BLADE WIDTH		BOX/CTN
	feet	meters	inches	mm	
30-486N	10'	3	1/2"	12.7	6/36
30-496N	16'	5	3/4"	19	6/36
30-456N	26'	8	1"	25	6/24

New STANLEY® Fatmax Tapes



33-719

- 11' blade standout
- 1-1/4" wide blade for easy readability
- BladeArmor™ coating on the first 4-1/2" maximizes durability of the blade
- Mylar® polyester film extends life of entire blade
- High-impact ABS case with durable rubber-holds up to heavy use
- Top-forward blade lock makes locking and unlocking easy
- 16" and 19.2" stud center markings simplify framing jobs
- Cushion grip provides comfortable, slip-resistant hold
- Specially designed multi-catch hook grabs on top or bottom for versatility
- Three-rievet, corrosion-resistant Tru-zero end hook for accurate measurements

SKU#	BLADE LENGTH		BLADE WIDTH		BOX/CTN
	feet	meters	inches	mm	
33-719	16'	5	3/4"	19	6/12
33-726	26'	8	1"	25	4/24
33-805	33'	10	1-1/4"	31	1/24

Mylar® is a registered trademark of DuPont Teijin Films for its polyester film. Only Dupont Teijin Films makes Mlyar® polyester film.

New STANLEY® Fatmax XI Tapes



33-887

- 13' blade standout
- 1-1/4" wide blade for easy readability
- 150% larger hook (compared to STANLEY® 1" tapes) designed to grab on side, top or bottom for versatility
- BladeArmor™ coating on the first 6" maximizes durability of the blade
- High-visibility Mylar® polyester film extends life of entire blade and provides visibility in low lighting
- Chrome case with durable rubber-holds up to heavy use
- AirLock™ rubber slide lock is resistant to impact and makes locking and unlocking easy
- 16" and 19.2" stud center markings simplify framing jobs

SKU#	BLADE LENGTH		BLADE WIDTH		BOX/CTN
	feet	meters	inches	mm	
33-887	-	5	1-1/4"	-	4/24
33-892	-	8	1-1/4"	-	4/24
33-897	-	10	1-1/4"	-	4/24

STANLEY® RubberGrip® Tape Rule



30-608L

- Exclusive cushion grip built into case for comfortable non-slip and impact resistance
- Lacquered blade for maximum durability
- Improved blade readability with high contrast colour easy to read in all lighting conditions
- Massive bumper designed for increased hook life

SKU#	BLADE LENGTH		BLADE WIDTH		BOX/CTN
	feet	meters	inches	mm	
30-608L	-	3	1/2"	12.7	6/36
30-611L	-	3.5	1/2"	12.7	6/36
30-616	-	5	1/2"	12.7	6/36

STANLEY® Tylon Tape



30-696

- Entire Blade coated with Mylar polyester film for added durability
- 16" and 19.2" stud center markings simplify framing jobs
- Compact, ergonomic case is 10% smaller than PowerLock® classic tapes, making it perfect for smaller settings
- ABS, shock-proof, chrome steel case
- 3-rivet, corrosion-resistant hook moves for accurate inside/outside measurements
- Forward blade lock design simplifies locking and unlocking the blade
- Wear plate protects case from cuts and nicks
- Belt clip on back of case

SKU#	BLADE LENGTH		BLADE WIDTH		BOX/CTN
	feet	meters	inches	mm	
30-696	16'	5	1"	25	6/36
30-656	26'	8	1"	25	6/36

STANLEY® Leverlock® Tape Rule



30-815

- Unique power-return feature, with automatic bottom lock, streamlines tape operation
- High-visibility case makes it easy to find in a tool box or on the job
- Special Tru-Zero hook does double-duty as a pivot for drawing circles and arcs
- Three-rivet, corrosion-resistant hook for durability (1" blades only)
- Polymer coating and heat-treated spring extends life
- Belt clip on back of case assures effortless accessibility

SKU#	BLADE LENGTH		BLADE WIDTH		BOX/CTN
	feet	meters	inches	mm	
30-808	10'	3	1/2"	12.7	6/36
30-815	16'	5	3/4"	19	6/36
30-824	26'	8	1"	25	4/24
30-809	-	3	-	12.7	6/36
30-854T	25'	-	1"	-	12/12

STANLEY® Powerlock® Tape Rule



33-428-2

- Highly resistant chrome plated plastic case
- Belt Clip
- Tru-Zero hook
- Class II Accuracy
- Anti abrasion Mylar® polyester film coated blade for long life

SKU#	BLADE LENGTH		BLADE WIDTH		Box/CTN
	feet	meters	inches	mm	
33-231-2	10'	3	1/2"	13	6/36
33-215-2	12'	3.5	1/2"	13	6/36
33-158-2	16'	5	3/4"	19	6/36
33-428-2	26'	8	1"	25	6/24
33-463-2	33'	10	1"	25	6/24
33-218-2	-	3	-	13	6/36
33-194-2	-	5	-	19	6/36

STANLEY® Contractor Grade™ Open Reel Fiberglass LongTape



34-791

- 26 Strand 12mm wide blade
- PVC blades allow wound wet and easily cleaned
- Metric English blade printed both sides
- Bi-material handle and shaped winder for ease of use
- Class III Accuracy
- High-impact ABS case withstands rugged conditions

SKU#	BLADE LENGTH		BLADE WIDTH		Box/CTN
	feet	meters	inches	mm	
34-791	100'	30	1/2"	13	2/8
34-794	200'	60	1/2"	13	2/8
34-792	-	30	-	13	2/8
34-795	-	60	-	13	2/8
34-777	300'	100	1/2"	13	2/8

STANLEY® Fiberglass LongTape

- 26 strands, 12mm wide blade
- 2 colour graduations - easy to read in all conditions
- High impact, high visibility yellow ABS case
- Handle folds for storage
- Class III Accuracy



34-260

SKU#	DESCRIPTION	BLADE LENGTH		BLADE WIDTH		Box/CTN
		feet	meters	inches	mm	
34-260	LONG TAPE CLOSED F/G 15M	50'	15	1/2"	13	6/60
34-262	LONG TAPE CLOSED F/G 30M	100'	30	1/2"	13	6/42
34-263	LONG TAPE CLOSED F/G 50M	165'	50	1/2"	13	6/36
34-295	FIBERGLASS LONG TAPE CASE 10M	-	10	-	13	6/72
34-296	FIBERGLASS LONG TAPE CASE 20M	-	20	-	13	6/60
34-297	FIBERGLASS LONG TAPE CASE 30M	-	30	-	13	6/42
34-298	FIBERGLASS LONG TAPE CASE 50M	-	50	-	13	6/36

STANLEY® Steel LongTape

- 9.5mm wide yellow blade with abrasion resistant polymer coating for durability
- 2 colour graduations - easy to read in all conditions
- High impact, high visibility yellow ABS case
- Hook with spurs for ease of use
- Class III Accuracy



34-108N

SKU#	DESCRIPTION	BLADE LENGTH		BLADE WIDTH		Box/CTN
		feet	meters	inches	mm	
34-104N	15M/50' STEEL LONG TAPE	50'	15	3/8"	9.5	6/24
34-107N	30M/100' STEEL LONG TAPE	100'	30	3/8"	9.5	6/24
34-105N	STEEL LONG TAPE 20M	-	20	-	9.5	6/24
34-108N	STEEL LONG TAPE 30M	-	30	-	9.5	6/24
34-132N	30M/100' FATMAX ST. LONG TAPE	100'	30	3/8"	9.5	6/24

New STANLEY® High Impact ABS Level



- Durable, shock-resistant ABS construction
- Top-read center vial for improved readability
- Measuring scale adds utility
- Non-marring material helps prevent damage to finished surfaces
- High-visibility yellow is easy to spot on the job site



42-476

SKU#	DESCRIPTION	LENGTH inches	# OF VIALS	BOX/CTN
42-466	Plastic, Non-Magnetic	12"	3	-/10
42-467	Plastic, Non-Magnetic	18"	3	-/6
42-468	Plastic, Non-Magnetic	24"	3	-/6
42-470	Plastic, Non-Magnetic	48"	3	-/6

SKU#	DESCRIPTION	LENGTH cm	# OF VIALS	BOX/CTN
42-474	Plastic, Non-Magnetic	30	3	-/10
42-475	Plastic, Non-Magnetic	45	3	-/6
42-476	Plastic, Non-Magnetic	60	3	-/6
42-471	Plastic, Non-Magnetic	120	3	-/6

New STANLEY® Classic Box Level



- Solid block center vial magnified for easier reading and accurate to 0.0005"/in and 0.5mm/m
- Enlarged plumb vials over 25% larger than standard vials for easy reading
- Plumb vials feature clear covers for protection and easy cleaning
- Shock-absorbing end caps protect level
- New concave body design provides durability and comfortable handling



SKU#	DESCRIPTION	LENGTH cm	# OF VIALS	BOX/CTN
43-102	Non-Magnetic	40	2	-/10
43-103	Non-Magnetic	60	2	-/10
43-104	Non-Magnetic	80	2	-/10
43-105	Non-Magnetic	100	3	-/10
43-106	Non-Magnetic	120	3	-/10
43-107	Non-Magnetic	150	3	-/6
43-108	Non-Magnetic	180	3	-/6
43-109	Non-Magnetic	200	3	-/6

**New STANLEY®
Classic Box Level (Magnetic)**

NEW



- Solid block center vial magnified for easier reading and accurate to 0.0005"/in and 0.5mm/m
- Enlarged plumb vials over 25% larger than standard vials for easy reading
- Plumb vials feature clear covers for protection and easy cleaning
- Shock-absorbing end caps protect level
- New concave body design provides durability and comfortable handling
- Precision milled utile surface for accuracy

SKU#	DESCRIPTION	LENGTH		# OF VIALS	BOX/CTN
		cm	inches		
43-110	Magnetic	40	16"	2	-/10
43-111	Magnetic	60	24"	2	-/10
43-112	Magnetic	80	32"	2	-/10
43-113	Magnetic	100	40"	3	-/10
43-114	Magnetic	120	48"	3	-/10
43-115	Magnetic	150	60"	3	-/6
43-116	Magnetic	180	72"	3	-/6
43-117	Magnetic	200	80"	3	-/6

STANLEY® Fatmax™ Xtreme Box Beam Level (Non-Magnetic)



43-648

- Durable box-beam construction is up to 5x stronger than other STANLEY® levels
- Block vials provide accuracy of 0.0005 in/in (0.5mm/m)
- Magnified center vial for improved visibility
- Machined levelling surfaces improves accuracy
- Lifetime Accuracy Warranty

SKU#	DESCRIPTION	LENGTH		# OF VIALS	BOX/CTN
		inches	cm		
43-624	Non-Magnetic	24"	610	3	3/3
43-648	Non-Magnetic	48"	1219	3	3/3
43-672	Non-Magnetic	72"	1829	3	3/3

STANLEY® FatMax™ Xtreme Box Beam Level (Magnetic)



43-625

- Same features as non-magnetic Box Beam Levels but with rare earth magnets
- Rare earth magnets are twice as strong as basic strip magnets, are built into the level for stability

SKU#	DESCRIPTION	LENGTH		# OF VIALS	BOX/CTN
		inches	cm		
43-625	Magnetic	24"	610	3	3/3
43-649	Magnetic	48"	1219	3	3/3

STANLEY® Fatmax™ II Level (Non-Magnetic)



43-548

- Built from a single piece of aluminum extrusion for increased durability and rugged use
- Feature 2 block vials on each end to provide maximum accuracy
- A center MaxEdge™ vial enables users to scribe continuous lines with an improved view
- Dual bi-material

SKU#	DESCRIPTION	LENGTH		# OF VIALS	BOX/CTN
		inches	cm		
43-524	Non-Magnetic	24"	610	3	6/6
43-536	Non-Magnetic	36"	914	3	6/6
43-548	Non-Magnetic	48"	1219	3	3/3
43-572	Non-Magnetic	72"	1829	3	3/3

STANLEY® Fatmax™ II Level (Magnetic)



43-525

- Built from a single piece of aluminum extrusion for increased durability and rugged use
- Feature 2 block vials on each end to provide maximum accuracy
- A center MaxEdge™ vial enables users to scribe continuous lines with an improved view
- Dual bi-material

SKU#	DESCRIPTION	LENGTH		# OF VIALS	BOX/CTN
		inches	cm		
43-525	Magnetic	24"	610	3	3/3
43-537	Magnetic	36"	914	3	6/6
43-549	Magnetic	48"	1219	3	6/6

STANLEY® I-Beam Pro180° Level



42-920



42-923



42-919

- Rigid I-Beam cross section features low profile, shock-absorbing end caps for durability
- 180° rotating view for a range of situations
- Durable I-Beam Girder Section Aluminium Body
- Measuring scale printed directly on the level eases layout work
- Powder-coated frame withstands nicks and offers a comfortable hold
- Clear acrylic vial covers for easy readability
- 3 tubular vials: 1 top read level vial, 1 plumb vial and 1 180° rotating angle vial (double graduation for 0° up to 90° and in 10° markings)
- Accuracy +/- 1.5mm/m (0.0015in/in)

SKU#	LENGTH		# OF VIALS	ACCURACY IN		BOX/CTN
	mm	inches		mm/m	inches	
42-919	400	16"	2	1.5	0.0015	6/6
42-920	600	24"	3	1.5	0.0015	6/6
42-921	800	32"	3	1.5	0.0015	6/6
42-922	1000	40"	3	1.5	0.0015	3/6
42-923	1200	48"	3	1.5	0.0015	6/6

1 MEASURING & LAYOUT TOOLS
2 LASER MEASURING SYSTEM
3 CUTTING & HOLDING TOOLS
4 FASTENING TOOLS
5 STRIKING & STOCK TOOLS
6 ILLUMINATION TOOLS
7 PAINTING & FINISHING TOOLS
8 MECHANICAL TOOLS
9 TOOLS STORAGE
10 POWER TOOL CLEANING TOOLS
11 POWER TOOLS
12 POWER TOOL ACCESSORIES
13 PRODUCT INDEX

New STANLEY® Fatmax® I-Beam Level (Non-Magnetic)

NEW



43-553

- Aluminum body removes excess dirt and prolongs life
- Solid vials for better control and less slips
- Magnified center vial for more user comfort
- Vials accuracy of 0.5mm/m for improved accuracy
- Top read scale for fast measurements
- MaxEdge center vial : bridged center vial for continuous marking surface
- Shock absorbing end caps makes it long lasting & shock resistant
- Pencil included, quick help for marking
- Accuracy +/- 1.5mm/m (0.0015in/in)

SKU#	DESCRIPTION	LENGTH inches	# OF VIALS	BOX/CTN
43-553	Non-Magnetic	24"	3	2/2
43-555	Non-Magnetic	48"	3	2/2
43-557	Non-Magnetic	72"	3	2/2

New STANLEY® Fatmax I-Beam Level (Magnetic)

NEW



43-554

- Aluminum body removes excess dirt and prolongs life
- Solid vials for better control and less slips
- Magnified center vial for more user comfort
- Vials accuracy of 0.5mm/m for improved accuracy
- Top read scale for fast measurements
- MaxEdge center vial : bridged center vial for continuous marking surface
- Shock absorbing end caps makes it long lasting & choc resistant

SKU#	DESCRIPTION	LENGTH inches	# OF VIALS	BOX/CTN
43-554	Magnetic	24"	3	2/2
43-556	Magnetic	48"	3	2/2
43-558	Magnetic	78"	3	2/2

I-Beam Level - Top Read

- Durable, lightweight aluminium construction suited to all purpose use
- Pipe groove allows use on round objects
- Top-read center vial designed for easy readability
- Yellow vial covers increase visibility and readability
- Shock-absorbing end caps hold up to heavy use
- Hang hole simplifies storage
- Replaceable 360° vials and cover

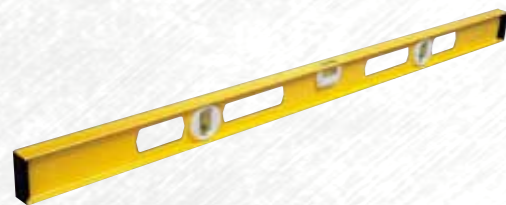

42-075

SKU#	LENGTH		# OF VIALS	BOX/CTN
	mm	inches		
42-072	305	12"	2	10/10
42-073	457.5	18"	3	5/5
42-074	610	24"	3	5/5
42-075	915	36"	3	5/5
42-076	1220	48"	3	5/5

STANLEY® Box Level

- Box Section Level for DIY
- Lightweight aluminium box section body
- 2 plumb, 1 horizontal vial, permanently fixed
- Easy to clean epoxy finish to all surfaces
- Accurate to 1.0mm/m



42-362

SKU#	LENGTH		# OF VIALS	BOX/CTN
	mm	inches		
42-362	300	12"	2-level/plumb	20/20
42-643	457	18"	3-level/plumb	20/20
42-684	600	24"	3-level/plumb	10/10
42-685	915	36"	3-level/plumb	10/10
42-686	1220	48"	3-level/plumb	10/10

STANLEY® Contractor Grade™ Torpedo Level

- Combines accuracy and lightweight, ideal for all small installations
- 3 vials: horizontal, plumb and 45°



42-465

SKU#	LENGTH		# OF VIALS	BOX/CTN
	mm	inches		
42-465	229	9"	3level/45°/1Plumb with Magnetic Base	6/36

STANLEY® Torpedo Level

- High-impact ABS plastic for durability
- Handy and economical
- 3 vials: horizontal, plumb and 45°



42-294

SKU#	DESCRIPTION	LENGTH		# OF VIALS	BOX/CTN
		mm	inches		
42-264	Magnetic	229	9"	3(level/45°/1Plumb)	6/36
42-291	Magnetic	203	8"	3(level/45°/1Plumb)	4/36
42-294	Standard	203	8"	3(level/45°/1Plumb)	4/24

STANLEY® Line Level

- Special hooks allow level to slide freely
- Flat bottom for surface leveling
- High visibility tinted liquid provides clear readings



42-287-0

SKU#	DESCRIPTION	LENGTH	# OF VIALS	BOX/CTN
42-287-0	LEVEL LINE 3-1/4"-1 YELLOW	3",76.2mm	1	6/72

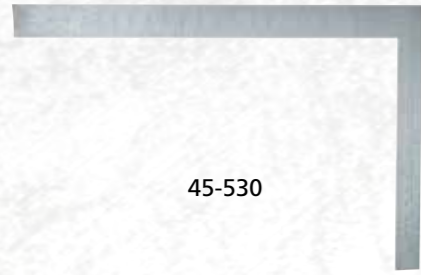

45-530

STANLEY® Steel Rafter / Roofing Square

- Embossed graduations and figures on work-hardened steel
- Metric roofing table
- Buffed finish with a clear lacquer that resists rust

SKU#	FINISH	LENGTH		GRADUATION		BOX/CTN
		BODY	TONGUE	FACE	BACK	
45-530 (Metric)	Buffed	600 x 500 mm	400 x 8 mm	2mm	2mm	6/6

STANLEY® Steel Carpenter Square



45-500

- Tempered steel designed for durability
- Deep graduations for easy reading on face and back
- Surface protected with a clear finish that resists rust
- Reverse reading scale makes measuring more efficient

SKU	FINISH	LENGTH		GRADUATION		BOX/CTN
		BODY	TONGUE	FACE	BACK	
45-500 (Imperial)	Buffed	24" x 12"	16 x 1-1/2"	1/8"	1/8"	1/4
45-600 (M/E)	Buffed	24" x 16"	16 x 1-1/2"	1/8"	1/8"	6/6

STANLEY® Try Square



46-530

- Try square with stamped graduations and figures
- Cast zinc handle
- Metric / Imperial marking on ruler

SKU#	BLADE		HANDLE		BOX/CTN
	mm	inches	mm	inches	
46-530	152	6"	124	4-7/8"	10/10
46-532	203	8"	124	4-7/8"	10/10
46-534	254	10"	184	7-1/4"	10/10
46-536	305	12"	184	7-1/4"	10/10

STANLEY® Combination Square

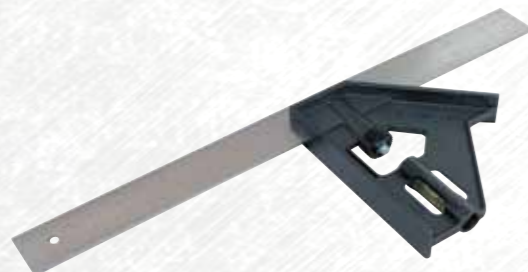

46-012

- Try square with stamped graduations and figures
- Cast zinc handle
- Metric / Imperial marking on ruler

SKU#	DESCRIPTION	LENGTH	# OF VIALS	BOX/CTN
		inches		
46-143	Combination, Metric, 11-13/16"	24"	3	10/60
46-012	12"	36"	3	6/6
46-028	Die cast	48"	3	3/3



46-825-0

STANLEY® Bevel Edge

- High carbon steel-tempered blade
- Nickel-plated
- Tough plastic handle

SKU#	DESCRIPTION		O/ A LENGTH		BOX/CTN
	mm	inches	mm	inches	
46-825-0	203	8"	140	5-1/2"	6/36

STANLEY® Maxstick Rule



45-103

- Rigid, yet lightweight aluminum construction
- Ideal for marking edges precisely
- Multi-purpose design provides an accurate measure and can also be used as a saw guide
- Laminated tape-rule guide is permanently adhered for durability
- Center gripping rib protects fingers
- Additional easy-to-read scale on back
- Helpful markings provide standard heights for light switches, dead bolts, door locks and electrical outlets

SKU#	LENGTH		BOX/CTN
	inches	mm	
45-103	48	1219.2	4/4

STANLEY® Digital Angle Finder



42-087

- Angle measurement 0° up to 180°
- Clear LCD Screen
- Horizontal and vertical vials
- Anodized aluminum profile
- Accuracy ± 0.1°

SKU#	DESCRIPTION	LENGTH	# OF VIALS	BOX/CTN
		cm		
42-087	Digital	40	2	1/4



47-460

STANLEY® Powerwinder® Chalk Line

- 3 1/2 to 1 gear ratio-rewind 3.5x faster
- Quick gear release-crank will not spin when pulling out line
- Clear view case-see amount of chalk inside case
- Case holds over 1.5 oz. of chalk
- Sliding door for quick and easy refill
- Weight and style combination provides "plumb bob" utility
- High impact ABS case

SKU#	LENGTH		BOX/CTN
	meter	feet	
47-460	30	100	1/6



47-465

STANLEY® Powerwinder® w/ Red Chalk And Line Level

- Kit contains one 100ft (30m) polypropylene chalk reel and 4oz (113gm)chalk container with blue chalk
- 3 1/2 to 1 gear ratio for 3.5 times faster rewind
- ClearView case to see the amount of chalk left inside
- Case holds 45g chalk
- Weight and style combination provides plumb bob utility
- Stainless steel end hook does not rust
- Sliding door for quick and easy refill

SKU#	LENGTH		BOX/CTN
	meter	feet	
47-465	30	100	5/5



47-440

STANLEY® Chalk Line

- On-board hook storage
- High impact ABS case for durability
- Sliding door for quick and easy refill
- Stainless steel end hook for added durability and rust prevention
- 1oz. chalk capacity

SKU#	LENGTH		BOX/CTN
	meter	feet	
47-440	30	100	6/24



47-443

STANLEY® w/ Blue Chalk And Line Level

- Kit contains 30m chalk line, 113g blue chalk
- High Impact ABS case for durability
- Sliding door for quick and easy refill
- Stainless steel end hook does not rust
- 30g chalk capacity
- Can be used vertically as a plumb bob

SKU#	LENGTH		BOX/CTN
	meter	feet	
47-443	30	100	2/6



47-487L

Fatmax® Xtreme™ Chalk Reel With Red Fatmax® Xtreme™ Chalk Kit

- Die-cast aluminum housing for durability
- Rewinds 5x faster – has a 5:1 gear ratio
- Quick gear release – crank will not spin when pulling out line
- Stainless steel hook and crank handle
- On-Board Hook Storage
- Patented ChalkView™ case – see amount of chalk inside case
- Premium polymer string resists breakage and fraying
- Includes 4 oz. waterproof red FatMax® Xtreme™ chalk

SKU#	DESCRIPTION	BOX/CTN
47-487L	Fatmax® Xtreme™ Chalkreel w/ Red Fatmax® Xtreme™ Chalk Kit	1/6



47-827

Fatmax® Xtreme™ 5Lb. Red Chalk

- Waterproof chalk will not fade or bleed in a wet environment
- Eliminates chalk clumping inside the chalk reel
- Square bottle will not roll off of work surfaces

SKU#	DESCRIPTION	BOX/CTN
47-827	Fatmax® Xtreme™ 5lb Red Chalk	4/4



47-828

Fatmax® Xtreme™ Chalk 5Lb. – Black

- Waterproof chalk will not fade or bleed in a wet environment
- Eliminates chalk clumping inside the chalk reel
- Square bottle will not roll off of work surfaces

SKU#	DESCRIPTION	BOX/CTN
47-828	Fatmax® Xtreme™ Chalk 5lb Black	4/4

STANLEY® Chalk Refills

- Powder specially formulated for good adhesion and high visibility
- Water Resistant
- Good resistance to all atmospheric conditions
- Blue: All round colour for interior and exterior use
- Red: Easier to use for external masonry work, inedible, easy to use



47-403

SKU#	WEIGHT		COLOUR	BOX/CTN
	grams	ounce		
47-403-1	113	4	Blue dot	12/12
47-404-1	113	4	Red dot	12/12
47-803-1	226	8	Blue Powder	12/12
47-804-1	226	8	Red Powder	12/12
47-808	226	8	Black Powder	12/12
47-809	226	8	Orange Powder	12/12
47-405-1	113	4	White Powder	12/12



47-064

STANLEY® Marking Gauge

- Plastic marking gauge
- Plastic stock with metal insert for abrasion resistance
- Stem calibrated for easy setting
- Graduation at 2mm

SKU#	DESCRIPTION	BOX/CTN
47-064	STANLEY® Marking Gauge	5/30



47-973

STANLEY® Solid Brass Plumb Bob

- Screw top to easily attach string to center of plumb
- Polished lacquered solid brass construction resists rust
- Thru hole for easy tightening
- Additional tip included on 8 oz size

SKU#	WEIGHT		LENGTH		BOX/CTN
	grams	ounce	mm	inches	
47-973	226	8	133	5 -1/4"	6/36

2 LASER MEASURING SYSTEM

ACCURACY, DEPENDABILITY & DURABILITY

STANLEY®'s team of world-class engineers and industrial designers has developed a series of versatile electronic tools that deliver an unprecedented level of accuracy, reliability and long-term performance. The lineup includes three different laser distance measurers. These handheld, battery-powered devices feature state-of-the-art electronics and easy read LCD screens that make the process of taking long measurements or performing complex calculations fast and easy. The range of STANLEY® Laser Distance Measurers is designed to accelerate both the estimating and execution of jobs for a wide range of people, making them more productive.

People like:

- Builders and remodelers
- Tradesmen, like drywallers, painters, flooring installers
- Inspectors, appraisers, realtors, architects
- Homeowners/DIYers

Regardless of the application, STANLEY®'s Laser Measuring Systems are a perfect addition to any tool box.



THE MAIN TYPES OF STANLEY® LASER TOOLS



THE 4 MAIN FUNCTIONS OF LASER TOOLS



Angles and slopes

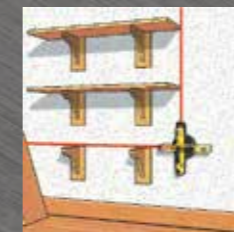

Squaring



Plumb line - take a point from floor to ceiling



Horizontal & vertical levelling & alignment

WHAT IS A LASER?

LASER stands for 'Light Amplification by Stimulated Emission of Radiation'. A diode is used to create a concentrated laser beam of light in one wavelength. The shorter the wavelength the brighter and more visible the laser beam. STANLEY® lasers have a standard wavelength of 635 nanometers, which is suitable for use up to 300m.

IP RATING

When working in dusty and damp conditions, the IP rating of the laser is also important. A selection of STANLEY® lasers are rated IP54 (dust resistant and splash proof) or IP66 (dust resistant and completely waterproof).

ARE LASERS POTENTIALLY HAZARDOUS?

Lasers are classed from 1 up to 4 in terms of potential hazard. STANLEY® laser classes range from class 1 up to class 2M, which pose little or no hazard.

Class 1 - Poses no threat of biological damage.

Class 2 - The output could harm a person if they

were to stare into a beam for a long period of time.

Class 2M - Lasers have a divergent beam and may be hazardous if an optical instrument is placed in front of the eye such as a magnifying glass.

LASER APPLICATION GUIDE

● : Functional for ... ● : Ideal use



SITE LAYOUT

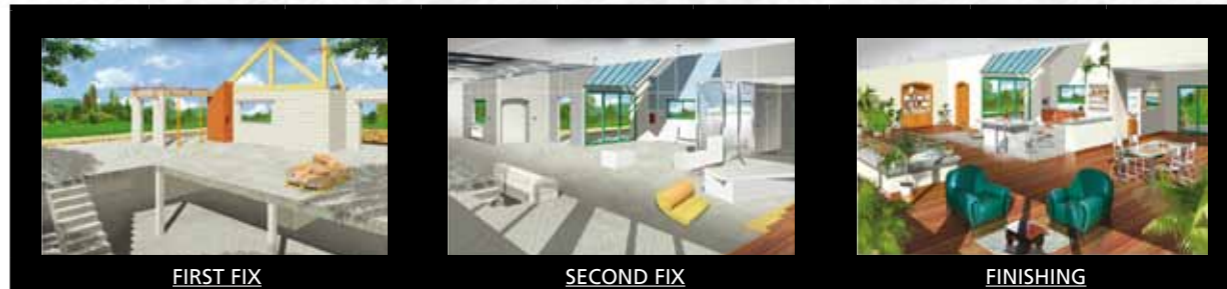

FIRST FIX

SECOND FIX

FINISHING

CATEGORY	PRODUCT DESCRIPTION	Levelling Foundation Form Work	Surface Levelling Drainage Gradings	Levelling Roads/Paths Driveways Landscaping
Optical Level	AL24 GVP Levelling Set 1-77-160	●	●	●
Rotary Laser	FatMax Rotary Laser RL HW+ 1-77-429	●	●	●
	FatMax Rotary Laser RL HGW 1-77-439	●	●	●
	FatMax Rotary Laser RL HVPW 1-77-427	●	●	●
Crossline Laser	FatMax Multiline Laser 1-77-122	●		●
	FatMax SML Multiline Laser 1-77-322	●		●
	Stanley SLL360 Line Laser 360° with Cross STHT1-77137	●		●
	FatMax CL2i Crossline Laser 1-77-120	●		●
	FatMax CL90i Crossline Laser 1-77-021	●		●
Combi Laser	SLP5 Self-Leveling 5-Point Laser Level 1-77-319	●		●
	SCL-D Self-Leveling Cross Laser 1-77-321	●		●
Spot Laser	FatMax PB5 Self-Leveling Multi-cross Dot Laser 1-77-119	●		
	FatMax PB3 Self-Leveling Multi-cross Dot Laser 1-77-118	●		
Laser Distance Measurer	TLM330 Laser Distance Measurer STHT1-77140			
	TLM165 Laser Distance Measurer STHT1-77139			
	TLM99 Laser Distance Measurer STHT1-77138			
Distance Measure (Ultrasonic)	Intellimeasure Ultrasonic Distance Estimator 0-77-018			

Squaring Up Walls Doors & Windows	Structural Steelwork Scaffolding	Plumbing Installation Electrical Installation	Installing Suspended Ceilings, Overhead Lighting	Multipoint Alignment, Tracks & Plumb Lighting, Partifications	Electrical Layout, Trunking & Pipework	Tiling, Panelling, Wallpapering	Kitchen Installation, Bathroom Installations	Shelving / Cabinets, Borders & Dado Rails, Interior Decorating
	●							
●	●	●	●	●	●	●	●	●
●	●	●	●	●	●	●	●	●
●	●	●	●	●	●	●	●	●
●	●	●	●	●	●	●	●	●
●	●	●	●	●	●	●	●	●
●	●	●	●	●	●	●	●	●
●	●	●	●	●	●	●	●	●
●	●	●	●	●	●	●	●	●
●	●	●	●	●	●	●	●	●
●	●	●	●	●	●	●	●	●
●	●	●	●	●	●	●	●	●
●	●	●	●	●	●	●	●	●
			●	●	●	●	●	●



- 1 STRIKING & LAYOUT TOOLS
- 2 LASER MEASURING SYSTEM
- 3 CUTTING & HOLDING TOOLS
- 4 FASTENING TOOLS
- 5 STRIKING & STRUCK TOOLS
- 6 ILLUMINATION TOOLS
- 7 PAINTING & FINISHING TOOLS
- 8 REPAIRING TOOLS
- 9 TOOL STORAGE
- 10 POWER CLEANING TOOLS
- 11 POWER TOOLS
- 12 POWER TOOL ACCESSORIES
- 13 PRODUCT INDEX

LASER DISTANCE MEASURING TOOLS

TLM330 True Laser Distance Measurer



STHT1-77140

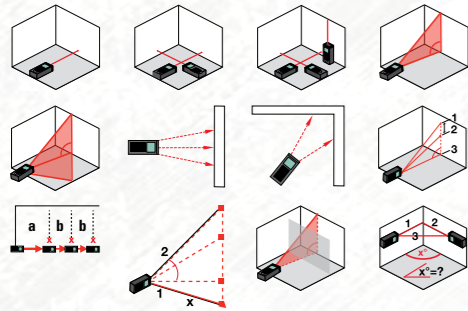

- Range: 330' (100m)
- Accuracy: +/- 1/32" (1mm)
- Distance/area/volume calculation
- Inclination sensor - Integrated digital leveling feature for leveling surfaces and identifying angles and position for accurate measurements
- Continuous measurement - Finds distance from a target quickly and easily
- Indirect measurement using Pythagoras - Measure distances even when point A and/or point B isn't accessible for linear measurement
- Memory - Unit stores last 20 measurements taken for reference
- Backlit, 3 line display - Large LCD provides visibility in all working conditions
- Multifunctional end piece - Folding end piece makes true corner-to-corner measurements easy and accurate
- Overmolded housing and IP 54 water/debris resistance - Durable product with high level of protection from dust/debris/water

SKU#	DESCRIPTION	BOX/CTN
STHT1-77140	TLM330 True Laser Distance Measurer	1/1

TLM165 True Laser Distance Measurer



STHT1-77139

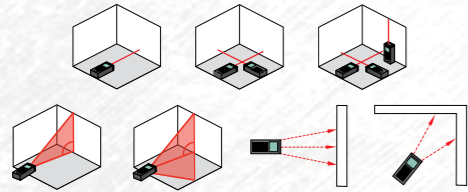

- Range: 165' (50m)
- Accuracy: +/- 1/16" (1.5mm)
- Distance/area/volume calculation
- Continuous measurement - Finds distance from a target quickly and easily
- Addition / subtraction - Convenient way to calculate in the field, using standard measurement units
- Indirect measurement using Pythagoras - Measure distances even when point A and/or point B isn't accessible for linear measurement
- Memory - Unit stores last 5 measurements taken for reference
- Backlit, 2 line display - Provides visibility in all working conditions
- Corner stand-off - End post makes true corner-to-corner measurements easy and accurate
- Overmolded housing and IP 54 water/debris resistance - Durable product with high level of protection from dust/debris/water

SKU#	DESCRIPTION	BOX/CTN
STHT1-77139	TLM165 True Laser Distance Measurer	1/1

TLM99 True Laser Distance Measurer



STHT1-77138

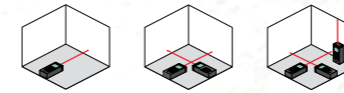

- Range: 100' (30m)
- Accuracy: +/- 3/32" (2mm)
- Distance/area/volume calculation
- Continuous measurement "tracking" function - Finds distance from a target quickly and easily
- Addition / subtraction - Convenient way to calculate in the field, using standard measurement units

SKU#	DESCRIPTION	BOX/CTN
STHT1-77138	TLM99 True Laser Distance Measurer	1/1

ULTRASONIC DISTANCE MEASURING TOOLS

Intellimeasure Ultrasonic Distance Estimator



0-77-018

- Calculates volume, distance and volumes
- Ultrasound measurement
- Measures distances up to 12meters / 40" at ± 0.5% accuracy
- Displays last 3 measurements
- Requires a 9V battery (not included)
- Maximum interior measurement 12m

SKU#	DESCRIPTION	BOX/CTN
0-77-018	Intellimeasure Ultrasonic Distance Estimator	1/1

OPTICAL LEVEL TOOLS

AL24 GVP Leveling Set



1-77-160

High quality, competitively priced 24X automatic optical level, supplied with Tripod and Rod, with many features normally seen on a high-priced product

- Large easy to use focusing knob
- Right angle prism for easy bubble viewing
- Large effective aperture with 30cm minimum range
- Fits to standard tripod
- Scope has sun-shade for bright light working
- Available in 360 degree or 400gon versions

SKU#	DESCRIPTION	BOX/CTN
1-77-160	AL24 GVP Leveling Set	1/1

ROTATING LASER TOOLS



1-77-429

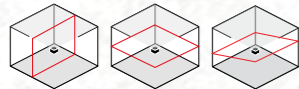

FatMax® Rotary Laser RL HW+

- Operates up to 300m range with a detector
- 0.05Mm/m accuracy – 600rpm rotation speed
- Grading function to set slopes up to +/- 6 degrees
- Rated to IP66 for total protection against dust and water
- Self-leveling
- Rechargeable battery lasting up to 24 hours between charges
- Supplied with a detector for external use, grid target, recharging lead and
- 4 x rechargeable batteries

SKU#	DESCRIPTION	BOX/CTN
1-77-429	FatMax® Rotary Laser RL HW+	1/4



1-77-439

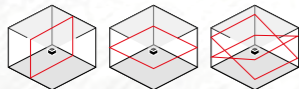

FatMax® Rotary Laser RL HGW

- Working range 600m
- The rotating head can be set up for a 15% slope
- Rotation Speed (RPM): 0 - 300 - 600 - 1000 - Automatic Leveling
- Anti-drift system
- Glass Enclosed Head Provides IP rating IP66
- Horizontal and Vertical Use

SKU#	DESCRIPTION	BOX/CTN
1-77-439	FatMax® Rotary Laser RL HGW	1/4

FatMax® Rotary Laser RL HVWP

- Operates up to 300m range with a detector / 0.05mm/m accuracy
- 0-300-600 rpm rotation speeds
- Grading function to set slopes up to +/- 6 degrees
- Scanning mode for 10-45-90 degrees / Self-leveling
- Rated to IP66 for total protection against dust and water
- Rechargeable battery lasting up to 24 hours between charges
- Supplied with wall mount, grid target, remote control, recharging lead,
- 4x C rechargeable batteries and laser glasses



1-77-427

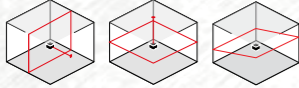

SKU#	DESCRIPTION	BOX/CTN
1-77-427	FatMax® Rotary Laser RL HVWP	1/4

CROSSLINE LASER TOOLS



1-77-122

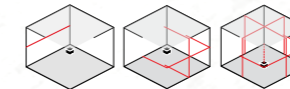

FatMax® Multiline Laser

- 25m range in interior and exterior working environment
- Projects 4 vertical laser lines, plus 1 horizontal line
- 3 leg tripod supplied attached to laser with smooth rotation mechanism
- Magnetically dampened pendulum
- 3 pendulum lock for safe transportation
- Delivered with tripod

SKU#	DESCRIPTION	BOX/CTN
1-77-122	FatMax® Multiline Laser	1/4



1-77-322

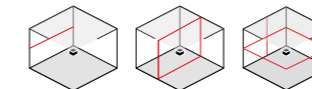

FatMax® SML Multiline Laser

- 50m working range with +/-0.15mm/m accuracy
- 1 horizontal line with 4 x 90o vertical lines, and down plump dot
- Detector delivers additional range and allows use in bright light situations
- Rotating base
- Durable design with IP54 debris and water resistance

SKU#	DESCRIPTION	BOX/CTN
1-77-322	FatMax® SML Multiline Laser	1/4



STHT1-77137

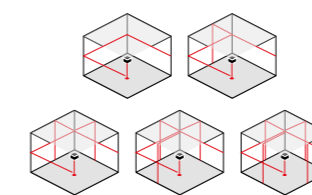

SLL360 Line Laser 360°

- Self-leveling 360o laser line and 1 vertical line
- 10m range with +/-0.4mm/m
- Fine vertical-adjust base for easy set-up
- Locking Pendulum
- Robust over-molded housing

SKU#	DESCRIPTION	BOX/CTN
STHT1-77137	SLL360 Line Laser 360°	1/4

FatMax® CL2I Crossline Laser



1-77-120

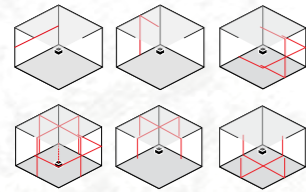

- 25m range
- 0.3mm/m accuracy
- Projects 1 horizontal and 1 vertical line to create a cross line
- Pulsed beam mode allows operation outdoors in combination with the detector (1-77-023)
- Out of True level sensor
- Self-leveling
- Runs on 3 x AA batteries (supplied)
- Pendulum lock for safe transportation
- Rated to IP54 to protect against dust and water splashes

SKU#	DESCRIPTION	BOX/CTN
1-77-120	FatMax® CL2I Crossline Laser	1/1

FatMax® CL90I Crossline Laser



1-77-021

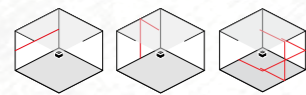

- Projects lines up to 30m using a detector (supplied)
- 0.33mm/m accuracy
- Projects 2 vertical and 1 horizontal line to create a cross line and a vertical line at 90 degrees to the right
- Pulsed beam mode allows operation outdoors in combination with the detector (supplied)
- Rated to IP54 to protect against dust and water splashes
- Self-leveling
- For laying out stud walling, pipe work, shelving, lighting, kitchens, fencing, landscaping & tiling

SKU#	DESCRIPTION	BOX/CTN
1-77-021	FatMax® CL90I Crossline Laser	1/1

COMBI LASER TOOLS

SLP5 Self-Leveling 5-point Laser Level



1-77-319

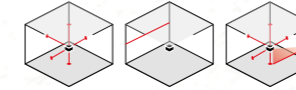

- Project 5 spot beams and 1 horizontal line
- 30m (spot) / 10m (line) working range
- Best in class accuracy +/- 0.3mm/m
- Provides dot visibility and clearance / alignment for wall track layout
- Magnetic pivoting base

SKU#	DESCRIPTION	BOX/CTN
1-77-319	SLP5 Self-Leveling 5-point Laser Level	1/4

SCL-D Self-Leveling Cross Laser



1-77-321

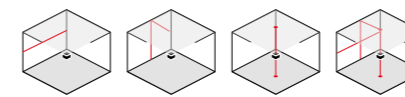

- Projects cross line and plumb spots
- 30m spot / 50m line working range with detector
- Best in class accuracy +/-0.3mm/m
- Pulse mode for use with detector
- Locking pendulum
- Robust over-molded housing
- Magnetic pivoting base

SKU#	DESCRIPTION	BOX/CTN
1-77-321	SCL-D Self-Leveling Cross Laser	1/4

SPOT LASER TOOLS

FatMax® PB5 Self-Leveling Multi-cross Dot Laser



1-77-119

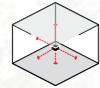

- 30m range, and interior and exterior working environment
- Projects 5 beams at 90 degrees to each other at 3x horizontal, 1x vertical and 1x plumb
- Magnetically dampened pendulum
- Trivet allows magnetization to steel frames, plus a universal thread for attaching to a pole or tripod
- Kit contains; laser grid target, trivet, carry case and 2x AA batteries

SKU#	DESCRIPTION	BOX/CTN
1-77-119	FatMax® PB5 Self-Leveling Multi-cross Dot Laser	1/10

FatMax® PB3 Self-Leveling Multi-cross Dot Laser



1-77-118

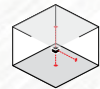



- Has a 30m range in an interior working environment
- Projects 3 beams at 90 degrees to each other at 1x horizontal, 1x vertical and 1x plumb
- Magnetically dampened pendulum
- Trivet allows magnetization to steel frames, plus a universal thread for attaching to a pole or tripod
- Kit contains; Laser grid target, carry case and 2x AA batteries

SKU#	DESCRIPTION	BOX/CTN
1-77-118	FatMax® PB3 Self-Leveling Multi-cross Dot Laser	1/10

DETECTORS APPLICATION GUIDE

●: Functional for ...

CATEGORY	PRODUCT DESCRIPTION	MATERIALS DETECTED				FEATURES			
		Moisture	Wood	Metal	Electric	Multi Depth	LCD Screen	AC Detection	Audible indicator
Sub-Surface Detectors	 IntelliLaser Pro2 (Fastener length: 12mm, 25mm, 38mm) 0-77-500		●	●	●	●	●	●	●
	 STANLEY Moisture Meter 0-77-030	●							

SUB-SURFACE DETECTORS TOOLS

IntelliLaser™ Pro Stud Sensor and Laser Line Level



0-77-500

- Horizontal, vertical and orientable laser line
- Detects wood and metal up to 38mm depth
- Detects electric cables (230v)
- Automatic calibration for fast operation
- Laser : 635nm - Class 2
- Batteries : 1 x 9V 6LR61 and 2 x batteries AAA LR03 (not included)

SKU#	DESCRIPTION	BOX/CTN
0-77-500	IntelliLaser Pro2	1/1

STANLEY® Moisture Meter



0-77-030

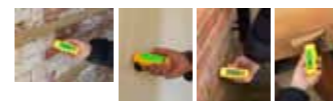

- Dual measurement scale, LCD display with bar graph
- Measures wood moisture from 6% to 44%
- Measures building material moisture from 0.2% to 2.0%
- Self-contained, pocket-sized meter
- Impact-proof housing
- CR-2032 button batteries included

SKU#	DESCRIPTION	BOX/CTN
0-77-030	STANLEY® Moisture Meter	1/1

LASER ACCESSORIES SELECTION GUIDE

● : Functional for ...

CATEGORY	CODE	ITEM DESCRIPTION	SUITABLE FOR															
			Optical Level	Rotary Laser				Crossline Laser				Combi Laser		Spot Laser		Laser Distance Measurer		
			1-77-160	1-77-429	1-77-439	1-77-427	1-77-122	1-77-322	STHT1-77137	1-77-120	1-77-021	1-77-319	1-77-321	1-77-119	1-77-118	STHT1-77140	STHT1-77139	STHT1-77138
Line Detector	1-77-023	FatMax Line Detector					●	●	●	●	●	●						
Laser Accessories	1-77-221	Professional Pole w/ Magnetic Mount					●	●	●	●	●	●						
	1-77-164	Aluminum Tripod 119cm to 292cm	●	●	●	●	●	●										
	1-77-163	Aluminum Tripod 97cm to 160cm	●	●	●	●	●	●										
	1-77-022	Stanley Laser Tripole					●		●			●	●					
	1-77-161	5 Section 5M Grade Rod Aluminum	●	●	●	●												
	1-77-201	Camera Tripod 1/4"					●		●			●	●					
	1-77-171	Laser Glasses		●	●	●	●	●	●	●	●	●	●	●	●	●	●	●



1-77-023



1-77-221



1-77-164



1-77-163



1-77-022



1-77-161



1-77-201



1-77-171

LINE DETECTOR TOOLS

FatMax® Line Detector



1-77-023

- Compatible with all STANLEY / FatMax line lasers with pulse mode
- 100m working range with +/-1mm accuracy
- 20mm window reception width
- 15 hours battery life
- For interior and exterior use

SKU#	DESCRIPTION	BOX/CTN
1-77-023	FatMax® Line Detector	1/1

LASER ACCESSORIES TOOLS

Professional Pole w/ Magnetic Mount



1-77-221

- Can be used with all line laser range
- Telescopic for easy transportation
- Aluminium, both strong and lightweight

SKU#	DESCRIPTION	BOX/CTN
1-77-221	Professional Pole w/ Magnetic Mount	1/1

Aluminum Tripod 119cm to 292cm



1-77-164

- Strong, aluminium body with cast flat baseplate
- Working height 1,02M to 2,92M
- Lightweight and durable aluminum hinge, clamp and shoe casting
- 5/8" thread

SKU#	DESCRIPTION	BOX/CTN
1-77-164	Aluminum Tripod 119cm to 292cm	1/1

Aluminum Tripod 97cm to 160cm



1-77-163

- Strong, aluminium body with cast flat baseplate
- Working height 1,02M to 2,92M
- Lightweight and durable aluminum hinge, clamp and shoe casting
- 5/8" thread

SKU#	DESCRIPTION	BOX/CTN
1-77-163	Aluminum Tripod 97cm to 160cm	1/1

STANLEY® Laser Tripole



1-77-022

- 5 section telescopic pole
- Comes with a tripod base for better stability
- Extends to 3.6 meters
- Can be used with 1-77-119, 1-77-118, 1-77-120, 1-77-121, 1-77-117, 1-77-122 and 1-77-021

SKU#	DESCRIPTION	BOX/CTN
1-77-022	STANLEY® Laser Tripole	1/5

Camera Tripod



1-77-201

- ¼ thread compatible with all line and spot lasers
- Compatible with LDMs

SKU#	DESCRIPTION	BOX/CTN
1-77-201	Camera Tripod	1/10

5 Section 5M Grade Rod Aluminum



1-77-161

- 5m overall with 5 sections graduated in cm & mm
- Strong, lightweight aluminium construction

SKU#	DESCRIPTION	BOX/CTN
1-77-161	5 Section 5M Grade Rod Aluminum	1/1

Laser Glasses



1-77-171

- Laser Glasses designed to enhance the brightness of the laser line internally and externally
- Suitable for: 1-77-118 3 Spot Laser Plumb Bob PB3.....
- 1-77-429FM Rotating Laser
- Important - these are not to be confused with laser SAFETY glasses

SKU#	DESCRIPTION	BOX/CTN
1-77-171	Laser Glasses	1/1

3 CUTTING AND HOLDING TOOLS

DURABLE, SHARP AND ERGONOMIC

STANLEY® manufactured its first utility knife back in 1935, and it didn't take long for the world to take notice. Compact, rugged, comfortable to hold and armed with a razor-sharp blade, it quickly became an indispensable tool for a wide variety of tradesmen, fabricators and installers. STANLEY® now makes nearly 60 different sizes and styles of utility knives. Specialty knives and blades manufactured for specific tasks, such as cutting carpeting, roofing materials, acrylic sheets, plastic laminates, linoleum and even sod. Some of the many features STANLEY® developed and first brought to market include its interlocking nose, which securely locks together the two knife halves for precise cutting, and an Instant Change™ design that allows you to quickly change blades without using a screwdriver to open the knife. This ingenious "no tools required" blade changing solutions on our utility knives and innovations like SharpTooth™ technology that enable our saws to cut wood 50% faster than conventional saws, sets us apart from our competitors.

FIXED BLADE KNIVES

These are designed for the heaviest of applications. Although the blade is fixed, the majority of STANLEY® Fixed Blade Knives incorporate a rapid blade changing mechanism.



RETRACTABLE BLADE KNIVES

These offer similar performance to the fixed blade models and the blade can be retracted safely into the handle when not in use.



SNAP-OFF BLADE KNIVES

The snap-off blade offers constant sharp edges, but is also strong and thick enough to apply heavy pressure without the blade breaking.



9MM SNAP-OFF BLADE KNIVES

The thinner 9mm Snap-off blade is ideal for thinner more delicate sheet materials and general craft work.



SAW SELECTION CRITERIA

There are three criterion upon which a saw could be judged :

1. The **SHAPE** of the teeth



2. The **SET** of the teeth



3. The **SHARPNESS** of the teeth



SHAPE & SIZE OF SAW TEETH



UNIVERSAL



JET CUT

The **SHAPE** and **SIZE** of the teeth determines the Speed of the saw and the Smoothness of the cut.

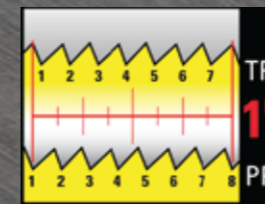

Low No. TPI :



fast cut, coarse finish

High No. TPI :

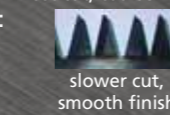

slower cut, smooth finish

* This is always denoted as the number of Teeth Per Inch (T.P.I.) and Points Per Inch (P.P.I.)

SET OF SAW TEETH

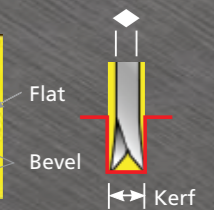

Teeth SET in Patterns:

Left, Right, Middle, Middle or Left x3, Middle, Right x3
Middle Teeth have no set and act as Rakers to clear out sawdust

PERFORMANCE

STANLEY® cutting tools are the best in its class, having features that ensure durability and performance such as:

- Blade Armor
- Tri-Material handle
- Sharpness and cutting life
- Application Specific
- Comfort and Ergonomic Instant-Change Handle

STANLEY® knives and blades are designed to work together to be more efficient, faster, safer and durable. In other words, the only things our tools don't cut are corners.

FatMax® Fixed Blade Utility Knife

NEW



10-780N

- Ergonomic design for ease of use
- Soft-touch panels/grips allow control, fewer slips
- Blade clamp eliminates blade wobble, gives control
- Pop-up blade dispenser for easy access and fast changeover
- Cartridge holds up to 5 blades
- Supplied with FatMax® blades
- Dual blade position in nose for versatility

SKU#	LENGTH		BOX /CTN
	mm	inches	
10-780N	160	6-1/4"	6/36

FatMax® Xtreme™ Twin Blade Knife

NEW



10-789

- 2 knives in 1 - new twin blade design allows the user to alternate between 2 blades without carrying more than 1 knife
- InstantChange™ feature allows the user to replace dull blades in seconds
- Easy access blade storage holds up to 9 blades for fast and easy blade change
- Interlocking blade sliders so that only 1 blade is extended at a time
- Rubber comfort grip minimizes fatigue and reduces slippage
- Knife includes 2 straight and 2 hook blades
- Total blade storage capacity - 11 (9 storage + 2 in use)

SKU#	LENGTH		BOX /CTN
	mm	inches	
10-789	175	6-7/8"	6/24

Classic 99 Retractable Utility Knife

- Interlocking nose to hold blade securely
- Three-position retractable blade
- Blade storage in handle
- Three blades included inside



10-099

SKU#	LENGTH		BOX /CTN
	mm	inches	
10-099	152	6"	6/36

FatMax® Retractable Utility Knife

- Adjustable thumb-dial locking wheel holds blade in place and prevents shifting
- Swivels open for quick blade change – no tools required
- Rear blade storage for seven blades
- Ergonomically designed rubber grip fits comfortably in hand
- Lightweight, durable body



10-777

FatMax

SKU#	LENGTH		BOX /CTN
	mm	inches	
10-777	165	6.5"	6/36

DynaGrip® Retractable Utility Knife

- Reduced heat/cold transfer
- Patented InterLock® nose secures blade
- Grip is non-slip, even with gloved hands, or on an angled surface
- Additional comfort in extreme temperatures
- 3 pcs blade in handle



10-779

SKU#	O / A LENGTH		BOX/CTN
	mm	inches	
10-779	144	5-5/8"	6/36

Retractable Utility Knife

- Light weight, economical utility knife
- Plastic & die cast zinc body shaped for comfort in use
- Multi-position blade slide
- 3 pcs Blade Storage handle



10-175

SKU#	O / A LENGTH		BOX/CTN
	mm	inches	
10-175	156	6-1/8"	6/36

InterLock® Self-Retracting Utility Knife

- Spring-loaded blade retracts automatically when pressure on slide button is released
- Patented interlocking nose secures blade safely between knife halves



10-189C

SKU#	O / A LENGTH		BOX/CTN
	mm	inches	
10-189C	144	5-5/8"	6/36

Plastic Retractable Knife

- Versatile plastic body knife
- Great for a variety of light duty cutting and trimming jobs
- Unique patented snap closure allows quick blade changes
- No need for a screwdriver
- Five position retractable blade
- Stainless steel blade carrier
- Furnished with one 11-921 Heavy Duty utility blade
- For light duty use only



10-065

SKU#	COLOR #	HANDLE LENGTH	NUMBER OF	
			BLADES	BOX/CTN
10-065	Yellow	152mm, 6"	1	6/36

Basic Snap-Off Knife



10-131 & 10-143

- Lightweight and economical snap-off blade knife
- Works with most light-weight applications
- Tips in use can be removed with the snapper at the end-cap of the knife
- Pocket clip included on the 9mm (10-131) Snap-Off Knife

SKU#	DESCRIPTION	BLADE WIDTH	O / A LENGTH		BOX/CTN
		mm	mm	inches	
10-131	9mm snap-off knife	9mm	137	5-3/8"	6/864
10-143	18mm snap-off knife	18mm	152	6"	6/432

18mm Standard Snap-Off Knife



10-280-0

- Made with stainless steel and high impact polymer components
- Smooth slider mechanism features an audible "click" and is self-locking for security
- Blade sections snap off to provide fresh, sharp cutting points
- Removable blade snapper included in cap of knife
- Hang hole for storage or lanyard
- High visibility spare blade holder designed for safety

SKU#	BLADE WIDTH	O / A LENGTH		BOX/CTN
	mm	mm	inches	
10-280-0	18	172	6-3/4"	12/72

18mm Snap-Off Cartridge Knife



10-380-0

- This 18mm Snap-Off Cartridge Knife has a 6-5/8" handle length
- Features a blade cartridge which rapidly and automatically slides new blade into position after old blade is removed
- Ergonomically designed for comfort and cutting power
- The smooth slider mechanism features an audible click-stop and is self locking for greater blade security
- Hang hole for storage or lanyard
- Blade capacity of six heavy duty blades or five extra heavy duty blades
- Supplied with three 11-301 heavy duty blades (equals 24 points)

SKU#	BLADE WIDTH	O / A LENGTH		BOX/CTN
	mm	mm	inches	
10-380-0	18	172	6-3/4" Handle 6-5/8"	6/36

18mm DynaGrip® Snap-Off Cartridge Knife



10-480

- Blade cartridge automatically slides new blade into position after old blade is removed
- Stainless steel blade dispenser cartridge resists rust
- Ergonomically designed for comfort and cutting power
- Smooth, slider mechanism features audible click stop and is self-locking
- Strong, durable tri-material construction with soft-grip panels
- Hang hole for storage or lanyard
- Blade capacity of six heavy duty or five extra heavy duty blades
- Comes with six 11-301 Heavy Duty blades (equals 32 points)

SKU#	BLADE WIDTH	O / A LENGTH		BOX/CTN
	mm	mm	inches	
10-480	18	Handle 172	6-3/4"	6/36

Quick Point Knife



10-150-0

- Light-duty, retractable knife with Quick-Point™ snap-off blades
- Blade sections snap off providing fresh, sharp cutting points
- Removable blade snapper included in cap of knife
- Pocket clip included
- Comes with one blade (equals 13 points)

SKU#	BLADE WIDTH	O / A LENGTH		BOX/CTN
	mm	mm	inches	
10-150-0	9	130	5-1/8"	6/72

Quick Point Knife



10-151-0

- Light-duty, retractable knife with Quick-Point™ snap-off blades
- Blade sections snap off providing fresh, sharp cutting points
- Removable blade snapper included in cap of knife
- Comes with one blade (equals 8 points)

SKU#	BLADE WIDTH	O / A LENGTH		BOX/CTN
	mm	mm	inches	
10-151-0	18	156	6-1/8"	6/72

9mm & 18mm Knives with DynaGrip®

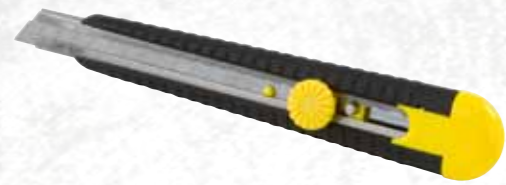

10-409



10-418

- Metal and high impact polymer construction for durability
- Blade sections snap-off providing the user with fresh, sharp cutting points
- Removable blade snapper included in cap of knife
- High impact polymer body contains elastomer for great grip and comfort
- Rigid stainless steel barrel provides smooth action and corrosion resistance
- Metal blade slide for positive blade positioning
- Pocket clip included on 10-409 9mm DynaGrip® Snap Off knife
- Supplied with one Quick-Point™ blade

SKU#	BLADE WIDTH		O / A LENGTH		BOX/CTN
	mm		mm	inches	
10-409	9		130	5-3/8"	12/72
10-418	18		152	6-1/2"	6/36

25mm Snap-Off-Knife with DynaGrip®



10-425

- Thumb dial blade release for easy blade change
- 25mm/1" snap-off blades to help resist snapping and adds durability
- 8 segments with 8 sharp tips
- Rubber DynaGrip® Panels for secure, comfortable grip
- Yellow ABS plastic body

SKU#	BLADE WIDTH		HANDLE LENGTH		BOX/CTN
	mm		mm	inches	
10-425	25		180	7"	6/72

Sport Utility™ Knife



10-804

- Comes with holster, blades dispenser & 10 pcs spare blades "sport" blade
- Retractable utility blade at opposite end allows for convenience when cutting applications change
- Rubber panels provide a comfortable non-slip grip
- Patented interlocking nose prevents knife halves from spreading
- Furnished with one 11-921 Heavy Duty utility blade

SKU#	HANDLE LENGTH		BOX/CTN
	mm	inches	
10-804	168	6-5/8"	2/6

STANLEY® 12-in-1 Multi-Tool



84-519K

- Stainless-steel construction
- High quality nylon holster
- Includes the following tools:

- * Long nose pliers
- * Curve jaw pliers
- * Wire cutter
- * Saw
- * Phillips® screwdriver
- * Standard screwdrivers (1/4", 5/16", 1/8")
- * Small knife
- * Large knife
- * Bottle opener
- * File

SKU#	DESCRIPTION	BOX/CTN
84-519K	STANLEY® 12-in-1 Multi-tool	1/1

Metal Mitey-Knife® Pocket Knife



10-239

- Rugged metal body
- Same silhouette as STANLEY® Interlock® knives
- Retractable blade with two cutting positions
- Two blades and handy keychain included

SKU#	DESCRIPTION	BOX/CTN
10-239	Metal Mitey-Knife® Pocket Knife	12/144

Carbide Utility Blade



11-800T

- Longest lasting blade on the job site
- Improved durability and wear. Lasts more than 5 times longer than competitive utility blades
- Tungsten Carbide durability and hardness is second only to diamond
- Steel body allows more flexibility to prevent breaking
- Meets contractors' needs and leads to greater productivity on the jobsite

SKU#	DESCRIPTION	BLADE PACK	BOX/CTN
11-800T	Carbide Utility Blade	10 Per Card	1/1

Classic 1992® Heavy Duty Utility Blade



11-921T

- Heavy-duty blade, ideal for carpet and vinyl
- Replacement blade for 10-099, 10-175, 10-777, 10-779 & 10-804

SKU#	#OF BLADES	BLADE			BLADE THICKNESS	BLADES PACK DETAILS	BOX/CTN
		LENGTH mm	WIDTH mm	inches			
11-921H	100	62	19	3/4"	0.65mm	10 Dispensers of 10pcs	1/24
11-921T	10	62	19	3/4"	0.65mm	10 per Dispensers	12/72

Large Hook Blade



11-983

- Sharpened hook with point for penetrating and cutting sheet material
- Replacement blade for 10-777, 10-779, 10-099, 10-175 & 10-804

SKU#	#OF BLADES	BLADE				BLADE THICKNESS	BLADES PACK DETAILS	BOX/CTN
		LENGTH mm	WIDTH mm	WIDTH inches	THICKNESS			
11-983-0	5	50	19	3/4"	0.65mm	Card (5)	10/10	
11-983-1	100	50	19	3/4"	0.65mm	Box of 100	1/20	

BLADE SELECTION GUIDE		BLADE				BOX/CTN
REPLACEMENT BLADE	SIZE	11-921H	11-921T	11-983-0	11-983-1	
10-099	3/4"	•	•	•	•	6/36
10-175	3/4"	•	•	•	•	6/36
10-777	3/4"	•	•	•	•	6/36
10-779	3/4"	•	•	•	•	6/36
10-804	3/4"	•	•	•	•	2/6

Quick-Point™ Blade



11-325-0

- Replacement blade for STANLEY 1" or 25mm snap-off knife 11-425

SKU#	#OF BLADES	LENGTH mm	BLADE WIDTH mm	BLADE WIDTH inches	BLADE THICKNESS	BLADES PACK DETAILS	BOX/CTN
11-325-0	10	110	25	1"	0.9 mm	10 pcs carded dispensers	10/100

Quick-Point™ Blade

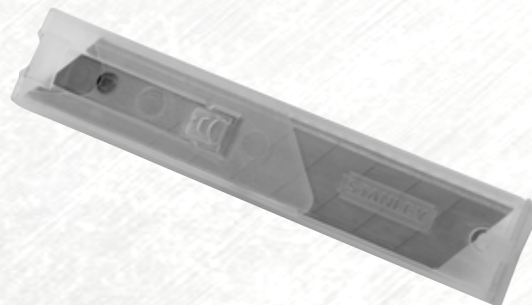

11-301T

- Replacement blade for 10-380, 10-280, 10-418, 10-151 and other 18mm snap-off knives
- Blade with 8 cutting points

SKU#	#OF BLADES	LENGTH mm	BLADE WIDTH mm	BLADE WIDTH inches	BLADE THICKNESS	BLADES PACK DETAILS	BOX/CTN
11-301T	10	110	18	3/4"	0.55mm	10 pcs dispensers	24/288
11-301H	100	110	18	3/4"	0.55mm	100 blades in dispensers of 10 each	1/27
11-300T	10	110	9	3/8"	0.43mm	10 pcs dispensers	48/576
11-300H	100	110	9	3/8"	0.43mm	100 blades in dispensers of 10 each	48/96

Carpet Knife Blade



11-525

- High carbon steel blade with double cutting edge
- Fits STANLEY® and most other carpet knives
- Five blades per card

SKU#	LENGTH #	PACKED	THICKNESS	BOX/CTN
11-525	2-1/4", 57.15mm	5/Card	.015"	10/100

BLADE SELECTION GUIDE		BLADE				BOX/CTN
REPLACEMENT BLADE	SIZE	11-301T	11-301H	11-325-0	11-325-1	
10-151-0	3/4"	•	•			6/72
10-280-0	3/4"	•	•			12/72
10-380-0	3/4"	•	•			6/36
10-418	3/4"	•	•			6/36
11-425	3/4"			•	•	6/72

Wood Handle Saw



20-502

- Machine set and sharpened teeth for accurate cutting
- High carbon steel blade hardened and tempered for sharpness and durability
- Comes with full length sleeve

SKU#	CONTENTS	TOOTH PATTERN	BOX/CTN
20-502	18"	Crosscut / 7TPI	12/24
20-503	20"	Crosscut / 7TPI	12/48
20-504	22"	Crosscut / 7TPI	12/24
20-505	24"	Crosscut / 7TPI	12/24

Plastic Handle Saw



20-080

- Handle offers a square/mitre feature with 45° and 90° angles
- Contoured sturdy handle designed for comfort and control
- Full length protective sleeve

SKU#	BLADE LENGTH	TOOTH PATTERN	BOX/CTN
20-080	18"	Crosscut / 6TPI	12/48
20-081	20"	Crosscut / 6TPI	12/48
20-082	22"	Crosscut / 6TPI	12/24
20-083	24"	Crosscut / 6TPI	12/24
20-004	18"	Crosscut / 7TPI	12/48
20-005	20"	Crosscut / 7TPI	12/48
20-006	22"	Crosscut / 7TPI	12/24
20-007	24"	Crosscut / 7TPI	12/24
20-026	26"	Crosscut / 7TPI	12/24

3 CUTTING AND HOLDING TOOLS

Clamping Mitre Box with Saw

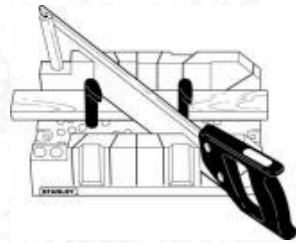

20-600

- One piece injection moulded mitre box for strength and durability
- Holds material securely for accurate cuts
- Material secures to the base with a twist of the cam pins
- Cuts miters on 45° and 90° angles, face angle 45° and 22-1/2° angles
- Molded-in storage compartments hold cam pins and pencil
- Molded lip on base edge for easy use without mounting
- Complete with fine tooth built-in backsaw to prevent cutting into mitre box
- Holes in base for fastening to workbench with patented cam lock clamping system which holds work piece securely in place.

DIMENSIONS IN MM				
SKU#	Length	Max. Height	Max Width	BOX/CTN
20-600	300	80	130	6/6

Thrifty® Backsaw



15-509

- Hardened and tempered steel for durability with contoured, molded handle for comfort

SKU#	BLADE LENGTH		TOOTH PATTERN	BOX/CTN
	mm	inches		
15-509	305	14"	12TPI	6/36

Hard Teeth Hand Saw



20-073

- Induction hardened teeth stay sharp up to 5 times longer than standard teeth
- Ergonomically designed handle for better grip and improved comfort

SKU#	BLADE LENGTH		TOOTH PATTERN	BOX/CTN
	mm	inches		
20-073	457	18"	Triple Teeth / 7TPI	4/24
20-074	508	20"	Triple Teeth / 7TPI	4/24

Mini Utility SharpTooth™ Saw



20-221

- 12- point induction hardened teeth stay sharp 3 to 5 times longer than standard teeth
- Aggressive 3-sided tooth design cuts wood 50% faster than conventional handsaws
- 10" blade is ideal for access in tight spaces and cutting a variety of materials such as plastic, particle board and wood
- Hardwood handle is contoured to fit the hand comfortably
- Compact 1 5-1/2" overall length fits conveniently in most toolboxes

SKU#	BLADE LENGTH		TOOTH PATTERN	BOX/CTN
	mm	inches		
20-221	254	10"	11 TPI	6/6

3 CUTTING AND HOLDING TOOLS

4-3/4" Depth FatMax® Coping Saw



15-104A

- Hardened, tempered blade provides clean, controlled cutting action
- Ergonomically designed cushion grip handle for comfort

SKU#	BLADE LENGTH	FRAME DEPTH	TOOTH PATTERN	BOX/CTN
15-104A	6-3/8"	4-3/4"	15 TPI	6/6

6-3/4" Depth FatMax® Coping Saw



15-106A

- Hardened, tempered blade provides clean, controlled cutting action
- Ergonomically designed cushion grip handle for comfort

SKU#	BLADE LENGTH	FRAME DEPTH	TOOTH PATTERN	BOX/CTN
15-106A	6-3/8"	6-3/4"	15 TPI	6/6

Coping Saw Blade



15-061

- State-of-the-art manufacturing processes produce strong, yet flexible blades that simply last longer
- Extra narrow blade for sharp surrounding cuts

SKU#	SIZE	TOOTH PATTERN	BOX/CTN
15-059	6-1/2"	20 TPI	10/50
15-061	6-1/2"	15 TPI	10/50

High-Tension Hacksaw and Metal Mini-Hack™ Utility Saw

NEW



20-036

- Pack includes 2 hacksaws – ideal for cutting metal & plastic.
- Rugged Design for Heavy Duty use.
- Quick Release blade changing mechanism maintains tension setting.
- Mni-Hack is lightweight, comfortable & durable.
- Mini-Hack's handle covers blade to help cover user's hand.

SKU#	DEPTH OF THROAT	HACKSAW	MINI-HACK	BOX/CTN
20-036	102mm (4")	305mm (12")	254mm (10")	8/8

3 CUTTING AND HOLDING TOOLS

SharpTooth™ Nest-Of-Saw

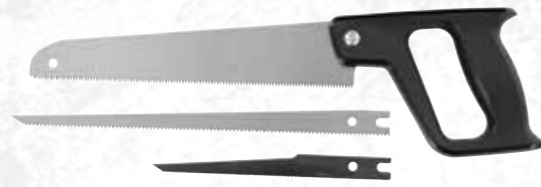

15-090

- 3 versatile interchangeable blades in a comfortable moulded handle
- Perfect for curves, circles and trim work
- Includes a fast-cutting 12" ShortCut® finishing made suitable for cutting moulding, PVC pipe and wood

SKU#	DESCRIPTION	BOX/CTN
15-090	3 Blades - consist of:	6/6
15-091	12" ShortCut® wood cutting blade	-
15-092	10" Compass Saw blade	-
15-093	6" Metal cutting blade	-

Multi-Purpose 3-in-1 Saw



20-092

- Ergonomically designed handle made with glass-filled, high strength nylon to support six different blade positions
- Diamond pattern and rubber over moulding on the handle allows end users to use the saw with reduced slip grip
- No tools required for blade change
- Integrated blade storage. The turn knob allows the user to conveniently store all 3 blades on the handle when not in use
- Multiple position handle allows access to tight corners
- 10" Universal blade cuts on the pull stroke and is less likely to jam or bend
- 10" Universal blade cuts through tree limbs, 2x4's and plastic pipes
- 8" Compass saw blade carves patterns and shapes out of wood
- 6" Metal cutting blade cuts through metal pipes and metal rods

SKU#	BLADE LENGTH		# OF BLADES	BOX/CTN
	inches			
20-092	6", 8" & 10"	3	2/8	

Folding Pocket Saw



15-333

- Folds like a jack knife for safe & easy storage
- Versatile for all cutting jobs
- Blade storage in handle

SKU#	CONTENTS	BLADE LENGTH		TOOTH PATTERN	BOX/CTN
		mm	inches		
15-333	Folding Pocket 8"/203mm	203	8"	11TPI	6/6
15-005	Replacement Blade	203	8"	11TPI	12/120

3 CUTTING AND HOLDING TOOLS

4-Way™ Keyhole Saw



15-275

- 4-Way™ blade positioning cuts curves circles and frets into places where an ordinary hacksaw cannot reach
- Cuts wood, nails, metal latch, composition board, BX cable, conduit, etc
- Lightweight, pistol grip handle fits hand
- Complete with one wood cutting blade and one metal cutting blade

SKU#	BLADE LENGTH		# OF BLADES	BOX/CTN
	inches			
15-275	1 pcs of Wood & 1 pcs of Metal cutting blade	2	6/6	

Junior Hacksaw



15-218-0

- Quick release hacksaw features a lever moulded into grip handle for easy blade change
- Deep throat for good work capacity
- 1 blade free

SKU#	OVERALL LENGTH		BLADE LENGTH		BOX/CTN
	mm	inches	mm	inches	
15-218-0	254	10"	150	6	10/60

10" Blade Length x 15 Points Per Inch Dovetail Saw



15-022

- This Dovetail Saw has a hardwood handle
- Cuts a true, smooth and narrow kerf
- Comfortably designed hardwood handle provides positive grip
- Fine cutting
- Comes with plastic blade guard for protection
- Blade Length 10", 254mm
- Points per inch 15

SKU#	LENGTH		BLADE SIZE		BOX/CTN
	mm	inches	mm	inches	
15-022	254	10"	254	10"	2/2

Steel Frame Hacksaw



15-166

- Positive locking mechanism
- Two blade position 90°/55°
- Aluminium handle - 12" blades

SKU#	LENGTH		BLADE SIZE		BOX/CTN
	mm	inches	mm	inches	
15-166	450	17-3/4"	305	12"	6/36

Tubular Frame Hacksaw



15-408

- Heavy gauge tubular steel frame nickel-plated will not tarnish or rust provides handy holding compartment for extra blades
- Easy adjustment of frame for 10" (255 mm) and 12" (305 mm) blade
- Blade can be faced in four directions
- Rugged cast handle with guard designed to protect knuckles
- Furnished with 10" (255 mm) standard carbon steel blade

SKU#	DEPTH OF THROAT		BLADE LENGTH		BOX/CTN
	mm	inches	mm	inches	
15-408	98	3-7/8"	255 & 305	10" & 12"	2/12

12" High Tension Hacksaw

NEW



15-113

- Rugged design for heavy-duty use
- Fully adjustable tension holds blade up to 32,000 psi – delivers fast, accurate cuts and long blade life
- Blade storage is integrated into frame
- Quick-release, blade-changing mechanism in handle maintains tension setting
- Blade can be positioned at 45° or 90° cutting angle
- Blade Length 12" / 305mm
- Throat Depth 3-7/8" / 98mm

SKU#	LENGTH		BLADE SIZE		BOX/CTN
	mm	inches	mm	inches	
15-113	98	3-7/8"	305	12"	2/12

10" v 12" Adjustable Blade Rubber Grip Hacksaw



15-265

- Easy adjustment of frame for 10" and 12" blades
- Rigid steel frame with molded cushion grip
- D-shape guard helps protect hands and knuckles
- Blade Length 10" / 254mm or 12"/305mm
- Throat Depth 3-7/8" / 98mm

SKU#	LENGTH		BLADE SIZE		BOX/CTN
	mm	inches	mm	inches	
15-265	98	3-7/8"	305	12"	6/6

10" Rod Saw - Carbide Grit Hacksaw Blade



15-410

- Tungsten carbide particles enable blade to cut on both forward and reverse strokes
- Makes thin straight cuts in ceramic, hardened steel, cast iron and masonry
- Fits standard hacksaw frame
- Blade Length 10" / 254mm

SKU#	LENGTH		BLADE SIZE		BOX/CTN
	mm	inches	mm	inches	
15-410	-	-	254	10"	100/100

10" v 12" Adjustable Blade Hacksaw



15-565

- Rugged plated steel frame
- Fits 10" and 12" blades
- Comfort pistol-grip handle
- Blade Length 10"/254mm or 12"/305mm
- Throat Depth 2-3/4" / 70mm

SKU#	LENGTH		BLADE SIZE		BOX/CTN
	mm	inches	mm	inches	
15-565	70	2-3/4"	254/300	10"/12"	6/6

12" Composite Hacksaw



15-892-2

- Patented design with I-beam frame construction
- 12" fixed blade frame is made of high-impact polymer with a steel core
- Sloped nose for access into hard-to-reach places
- Easy-open lever for quick blade change
- High-tension blade for straight accurate cuts
- Ergonomically designed, slip-resistant grip
- Blade Length 12"/305mm
- Throat Depth 4"/100mm

SKU#	LENGTH		BLADE SIZE		BOX/CTN
	mm	inches	mm	inches	
15-892-2	100	4"	100	4"	6/6

Mini-Hack™ Saw



20-807

- Ergonomically designed grip with thumb rest for maximum comfort
- 35mm cutting capacity
- Back blade stop for safe handling and use

SKU#	DEPTH OF THROAT		BLADE LENGTH		BOX/CTN
	mm	inches	mm	inches	
20-807	220	8-3/4"	254	10"	6/36

High Speed Steel Hacksaw Blade



15-988

- Teeth are precision milled and set
- Entire blade hardened to 65RC
- Cuts mild steel, cast iron, aluminium, copper
- Packed 100 per box

SKU#	O / A LENGTH		WIDTH/TEETH	BOX/CTN
	mm	inches	mm	
15-988	305	12"	1/2" x 0.025", 18T	1/10
15-984	305	12"	1/2" x 0.025", 24T	1/10

Bi-Metal HSS Hacksaw Blade



- Quality high speed steel bi-metal blades
- Cuts mild steel, cast iron, Aluminum, copper ranging from 1/8" to 1" in thickness
- Packed 100 per box

SKU#	O / A LENGTH		WIDTH/TEETH	BOX/CTN
	mm	inches	mm	
20-175	305	12"	1/2" x 0.025" x 18T	5/10
20-176	305	12"	1/2" x 0.025" x 24T	5/10
20-177	305	12"	1/2" x 0.025" x 32T	5/10

Hacksaw Blade



15-928A

- High carbon steel blades cut mild steel, cast-iron, aluminum, copper
- Good value for general use
- Blade Length 12" / 305mm
- Packed 2/Card
- Points per Inch 19
- Teeth per inch 18

SKU#	LENGTH		WIDTH / TEETH	BOX/CTN
	mm	inches	mm	
15-928A	305	12"	1/2" x 0.025" x 18T	10/100

Glass Cutter



14-125

- Die cast handle has a wide contoured comfort grip and ball end for tapping
- Steel wheel with general purpose cutting angle delivers precise scoring clean breakout, and smooth edges
- 3 Break-off notches for various depths
- Honed Cutting wheel
- Cuts glass up to 3 ram

SKU#	O / A LENGTH		BOX/CTN
	mm	inches	
14-125	130	5-1/8"	24/288

Precision Pliers

- 2 times longer cutting life 25% less cutting effort
- Cutting edge are precision ground & pre-finished before assembly for consistent performance
- Full collar, anti-slip ergonomic handle for comfort & superior gripping
- Machined teeth for maximum gripping in tight spaces
- Made of strong chrome vanadium material for longer lasting cutting
- Maximum anti-rust capability

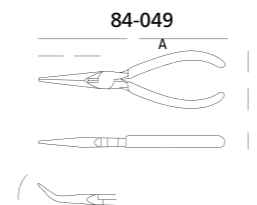
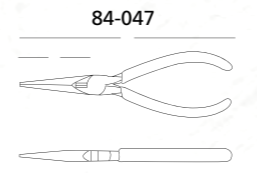
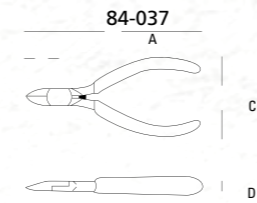

SKU#	DESCRIPTION	A (mm)	B (mm)	C (mm)	D (mm)	BOX/CTN
84-036	100mm/4" Precision Nipper Cutter	115	23.8	48	8	6/36
84-037	125mm/5" Precision Nipper Cutter	125	26.5	48.5	9	6/36
84-038	150mm/6" Precision Nipper Cutter	153	29.5	50	10	6/36

SKU#	DESCRIPTION	A (mm)	B (mm)	C (mm)	D (mm)	BOX/CTN
84-047	125mm/5" Precision Long Cutter	134.5	47	49.6	12	6/36
84-048	150mm/6" Precision Long Cutter	163.6	58	51.6	12	6/36

SKU#	DESCRIPTION	A (mm)	B (mm)	C (mm)	D (mm)	E (°)	BOX/CTN
84-049	125mm/5" Bent Nose	130.8	43.3	49.6	12	45°	6/36
84-054	150mm/6" Bent Nose	158.6	53	51.6	12	45°	6/36

FatMax® VDE Pliers

- Safe live line working to 1,000v
- Individually tested to 10,000v
- Compliant to EN60900, IEC/CEI900, VDE688
- Bi-material handle with secure grip grooving for comfort
- Heat treated high chrome steel forging for long life and durability
- Hand ground, induction hardened blade for long life and accuracy
- Finger guard for better control & added user safety
- Interlocking joint assembly for smooth cutting
- DIN/ ASO/ ANSI Compliant

SKU#	LENGTH DESCRIPTION	BOX/CTN
84-000	160mm/6" Combination (2101NV)	4/24
84-001	180mm/7" Combination (2201NV)	4/24
84-002	200mm/8" Combination (2301NV)	4/24

SKU#	LENGTH DESCRIPTION	BOX/CTN
84-003	180mm/7" Diagonal Pliers (2031NV)	4/24
84-004	200mm/8" Diagonal Pliers (2032NV)	4/24
84-005	210mm/9" Diagonal Pliers (2033NV)	4/24

SKU#	LENGTH DESCRIPTION	BOX/CTN
84-006	180mm/7" Long Nose Pliers (2021NV)	4/24
84-007	200mm/8" Long Nose Pliers (2023NV)	4/24

SKU#	LENGTH DESCRIPTION	BOX/CTN
84-008	200mm/8" Bent Nose Pliers (2023NBV)	4/24

SKU#	LENGTH DESCRIPTION	BOX/CTN
84-009	160mm/6-1/4" Narrow Head Diagonal Pliers	4/24

SKU#	LENGTH DESCRIPTION	BOX/CTN
84-011	3pcs Pliers Sets (84-001, 84-003 & 84-007)	4/4

SKU#	LENGTH DESCRIPTION	BOX/CTN
84-294	250mm/10" Water Pump Pliers (AA-01V)	4/24

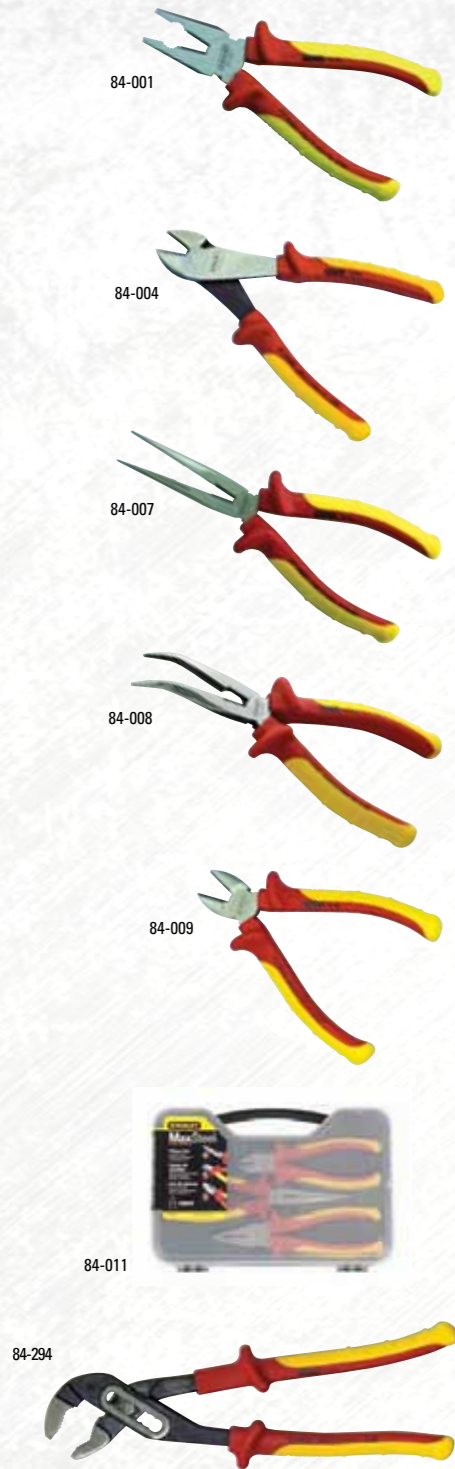

DYNAGRIP PLIERS

Linesman Pliers

- Gripping combined with cutting, known as side cutting pliers.
- Made popular by electricians
- Used for cutting as well as bending and twisting wire and as fish tape puller

SKU#	DESCRIPTION	LENGTH inches	BOX/CTN
84-623-2	6" HD combination plier - carbon steel, polished	6"	6/36
84-035-2	7" Linesman plier - carbon steel, polished	7"	6/36
84-029-2	8" Linesman plier - carbon steel, polished	8"	6/36
84-609-2	9" Linesman plier - carbon steel, polished	9"	6/36



84-029-2

Diagonal Pliers

- The cutting jaws are at an angle to the handles, allowing the user to cut close to a surface with the hand clear of obstructions. Also used for wire stripping

SKU#	DESCRIPTION	LENGTH inches	BOX/CTN
84-027-2	6" Diagonal cutting plier - carbon steel, polished	6"	6/36
84-028-2	7.5" HD diagonal plier - carbon steel, polished	7.5"	6/36
84-607-2	8" Diagonal plier - carbon steel, polished	8"	6/36



84-027-2



84-028-2

Groove Joint Pliers

- Originally designed for work on plumbing fittings, with serrated curved jaws to grip round objects

SKU#	DESCRIPTION	LENGTH inches	BOX/CTN
84-034-2	8" Groove joint plier - carbon steel, polished	8"	6/36
84-024-2	10" Groove joint plier - carbon steel, polished	10"	6/36
84-021-2	12" Groove joint plier - carbon steel, polished	12"	6/36



84-034-2



84-024-2



84-021-2

End Cutter Plier



84-077-2

- Used for cutting wire, cutting edge is at 90° to the handle, to allow close cropping of wire and is commonly used for tile cutting

SKU#	DESCRIPTION	LENGTH inches	BOX/CTN
84-077-2	6" End nipper plier - carbon steel, polished	6"	6/36
84-167-2	8" End nipper plier - carbon steel, polished	8"	6/36

Wire Strippers

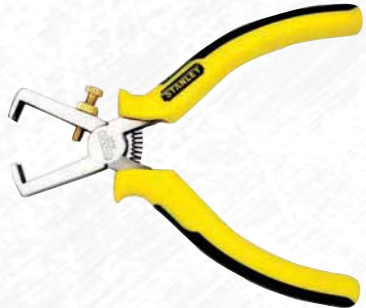

84-075-2

- Carbon Steel hardened cutting edges and jaws
- Heavy duty steel riveted joints
- Dyna grip handles for maximum comfort
- Hard chrome finish with anti-corrosion surface

SKU#	DESCRIPTION	LENGTH inches	BOX/CTN
84-075-2	6" Wire stripper - carbon steel, polished	6"	6/36

Bent Nose Pliers



84-071-2

- The angled nose is capable of gripping and manoeuvring objects in obstructed situations

SKU#	DESCRIPTION	LENGTH inches	BOX/CTN
84-071-2	6" Bent nose plier - carbon steel, polished	6"	6/36
84-072-2	8" Bent nose plier - carbon steel, polished	8"	6/36

Long Nose Pliers



84-031-2

- Smooth tapering jaws are capable of gripping and manoeuvring wire in confined areas. Also used to bend, loop and cut wire

SKU#	DESCRIPTION	LENGTH inches	BOX/CTN
84-031-2	6" Long nose plier - carbon steel, polished	6"	6/36
84-032-2	8" Pliers HD long nose - carbon steel, polished	8"	6/36

Slip Joint Pliers



84-055-2

- Provide reliable and sturdy grasping and prying ability
- Forged, chrome carbon steel construction meets or exceeds ANSI standards
- Rust-resistant finish, hardened edges for strength, and machined jaws for slip-resistant grip
- Double-dipped handles provide comfortable use

SKU#	DESCRIPTION	LENGTH inches	BOX/CTN
84-055-2	6" Slip joint plier - carbon steel, chrome plated	6"	6/36
84-026-2	8" Slip joint plier - carbon steel, chrome plated	8"	6/36

Flat Nose Pliers



84-073 -2

- With serrated, tapering jaws allowing manoeuvrability of small flat objects

SKU#	DESCRIPTION	LENGTH inches	BOX/CTN
84-073 -2	6" Flat nose plier - carbon steel, polished	6"	6/36

Round Nose Pliers



84-074-2

- Smooth tapering jaws are capable of gripping and manoeuvring wire in confined areas

SKU#	DESCRIPTION	LENGTH inches	BOX/CTN
84-074-2	6" Round nose plier - carbon steel, polished	6"	6/36

Miniature Pliers



84-096



84-125

- Small sized for precision work
- Chrome nickel for durability
- Double dip handles for comfort

SKU#	DESCRIPTION	LENGTH		BOX/CTN
		mm	inches	
84-119	Long Nose Pliers	127	5"	6/36
84-124	Diagonal Cutting Pliers	102	4"	6/36
84-096	Needle Nose Pliers	127	5"	6/36

SKU#	DESCRIPTION	LENGTH		BOX/CTN
		mm	inches	
84-125	End Nipper Pliers	102	4"	6/36
84-126	Bent Nose Pliers	127	5"	6/36
84-122	Flat Nose Pliers	102	4"	6/36

MaxSteel™ Aviation Snips



14-562



14-563



14-564

- Excellent for cutting aluminium, vinyl siding, screening, cardboard, leather & copper
- Exceeds ANSI standards for cutting performance and durability
- Double overwind spring for longer life
- High leverage, compound cutting design cuts up to 18-Gauge steel
- Patented hinge plate for easy product function identification

SKU#	LENGTH		CUT TYPE	CUTTING LENGTH	COPPER (SOFT)	CUTTING CAPACITY (mm)				BOX/CTN
	mm	inches				COLD-ROLLED STEEL (MILD)	HARD HRC30 (HARD)	HARD HRC40 (HARD)	STAIN-LESS STEEL 304	
14-562	254	10"	Left Curve	35	1.50	1.20	1.00	0.60	0.90	6/24
14-563	254	10"	Straight Cut	35	1.50	1.20	1.00	0.60	0.90	6/24
14-564	254	10"	Right Curve	35	1.50	1.20	1.00	0.60	0.90	6/24

MaxSteel™ All Purpose Snips (Straight Pattern)



14-556

- Exceeds ANSI Standards for cutting performance & durability
- Tough alloy steel blade
- Comfortable vinyl grips
- Cuts up to 0.78mm of cold rolled steel and 0.46mm of stainless steel

SKU#	O / A LENGTH		CUTTING CAPACITIES (MM)			BOX/CTN
	mm	inches	COPPER (SOFT)	COLD-ROLLED STEEL (MILD)	HARD STEEL HRC30 (HARD)	
14-569	178	7"	0.94	0.56	0.38	6/24
14-556	254	10"	0.94	0.78	0.6	6/24
14-558	305	12"	1.15	0.91	0.7	6/24

Tinsnips



14-164

- Drop-forged carbon steel material, hardened, tempered, grown, glazed & tested to last

SKU#	CUTTING CAPACITY		SIZE	BOX/CTN
	Cold-rolled Steel	Stainless Steel		
14-163	0.61	0.41	8"	6/36
14-164	0.78	0.45	10"	6/36
14-165	0.91	0.63	12"	6/24
14-166	1.20	0.70	14"	6/24

Bolt Cutter



14-308



14-312

- A range of bolt cutters in most popular sizes
- Cutter blades are of chrome molybdenum tempered steel with cutting jaws tempered HRC 60° (FBS std)
- Special heat treatment give blades extra hardness and durability

SKU#	LENGTH		MAX CUTTING LOAD (kg)	BOX/CTN
	mm	inches		
14-308	203	8"	36	6/48
14-312	305	12"	46	6/24
14-314	355	14"	54	6/24
14-318	457	18"	65	6/12
14-324	609	24"	61	2/6
14-330	762	30"	84	1/4
14-336	914	36"	104	1/4

Pruning Shears



14-302

- Blades of precision steel
- Cuts up to 18mm / 3/4" thickness
- Padded handle for comfort and reduced hand fatigue
- Safety lock feature

SKU#	O / A LENGTH		TYPE	BOX/CTN
	mm	inches		
14-302	200	8"	Bypass	10/60
14-303	200	8"	Anvil	10/60

STANLEY® Hedge Shear



74-390

- Lower blade middle carbon steel
- Aluminium handles with soft grip
- Tension adjustment
- Length 60 cm

SKU#	CONTENTS	BOX/CTN
74-390	Hedge Shear	6/12

STANLEY® Accuscape 6" Folding Pruner



74-906

- Ideal for cutting sheetrock tree limbs and firewood plumbing pipe and cutting screw heads off.
- Comfort grip. Folding saw.
- Aggressive teeth cut 50% faster.
- Push button positive lock and unlock.
- Easy and accurate cutting.
- Versatile for all cutting jobs.

SKU#	CONTENTS	BOX/CTN
74-906	6" Folding Pruner	6/48

Locking Pliers



84-370-1



84-368-1



84-396

- Serrated jaws made of chrome molybdenum material
- Heat-treated adjustable screw
- Long straight nose provides easy access in narrow, hard to reach places
- Ideal for precision work
- Curved jaws puts tremendous pressure on 4 points at any style or bolt head
- Straight jaws provides maximum contact on flat, square & hex work - ideal for welding & other metal work

SKU#	CONTENTS	LENGTH		BOX/CTN
		mm	inches	
84-367-1	Curved Jaw	127	5"	6/48
84-368-1	Curved Jaw	175	7"	6/36
84-370-1	Straight Jaw	175	7"	6/36
84-396	Long Nose	165	6.5"	6/48

Combination Snap Ring Pliers



84-168

- Internal- External positioning 45°- 90°-180°
- 10-50mm range

SKU#	LENGTH		BOX/CTN
	mm	inches	
84-168	152	6"	20/60

Locking Pliers with Bi-Material Handle



84-369-1



84-371-1



84-389

- Bi-material handle for anti-slip & comfort
- Serrated jaws made of chrome molybdenum material
- Heat treated adjustable screw
- Long straight nose provides easy access in narrow, hard to reach places
- Ideal for precision work
- Curved jaws puts tremendous pressure on four points at any style or bolt head
- Straight jaws provides maximum contact on flat, square & hex work - ideal for welding & other metal work

SKU#	CONTENTS	LENGTH		BOX/CTN
		mm	inches	
84-369-1	Curved Jaw	254	10"	6/36
84-371-1	Straight Jaw	254	10"	6/36
84-389	Long Nose	229	9.5"	6/36

Circlip Pliers



84-272

- Tempered alloy steel for strength and durability
- Rust resistant protective finish

SKU#	CONTENTS	BLADE LENGTH		BOX/CTN
		mm	inches	
84-271	Straight ext.	175	7"	12/120
84-273	Straight int.	175	7"	12/120
84-272	Bent ext.	175	7"	12/120
84-274	Bent int.	175	7"	12/120

Crimping Pliers



84-223

- Cuts electrical wires, strips insulation, shears screws and bolts clean (Warning: Grips do not protect against electrical shock.)

SKU#	O / A LENGTH		BOX/CTN
	mm	inches	
84-223 (Plier)	230	9"	10/100
84-253 (Set)	230	9"	6/36

Wire Stripper/Crimper AWG Standard



84-475

- Cuts electrical wires, strips insulation, shears screws and bolts clean (Warning: Grips do not protect against electrical shock.)
- Professional peeled, cut line ideal tool.
- can be used in the pressure line and a curved line.
- Laser etched scale - easy to see
- AWG (American Wire Gauge) is a distinction between the standard of the diameter of the wire; the larger the value, the smaller the diameter of the wire.

SKU#	Diameter (US Regulations)	O / A LENGTH			BOX/CTN
		Specifications (")	Length (mm)	Diameter (mm)	
84-475	AWG12-22	6	168	2.6 --- 0.6	10/100
84-477	AWG16-26	6	168	1.6 --- 0.5	10/100
84-325	AWG20-30	6	168	0.8 --- 0.25	10/100

Wire Stripper



84-214

- Convenient hole for looping or bending wire
- Ideal for cutting, stripping speaker wire & appliance cords
- Slide adjust for various gauge wire

SKU#	O / A LENGTH		BOX/CTN
	mm	inches	
84-214	130	5-1/4"	15/150

3 CUTTING AND HOLDING TOOLS

Water Pump Pliers



84-015

- Slim water pump pliers
- For use on pipes and nuts

SKU#	O / A LENGTH		BOX/CTN
	mm	inches	
84-015	254	10"	12/72

Tower Pincer



84-288

- Forged from high alloy steel with precision broached jaws & cutting edge

SKU#	DESCRIPTION	BOX/CTN
84-281	200mm Tower Pincer	6/36
84-282	250mm Tower Pincer	6/36
84-288	200mm HD Pincer	6/36

MaxSteel® Adjustable Wrench



90-948

- Bi-material cushion grip for comfort
- Use for plumbing, automotive or home use
- Precision machined face with etched measurement scale in English and Metric
- Strong chrome vanadium steel exceed ANSI specifications
- Slip-resistant bi-material cushion grip
- Rust-resistant phosphate coating
- Handy hang/storage hole in handle

SKU#	LENGTH		BOX/CTN
	mm	inches	
90-947	153	6"	2/12
90-948	203	8"	2/12
90-949	250	10"	2/12
90-950	305	12"	2/12

Adjustable Wrench



87-433-1

- Jaws fully hardened and tempered
- 25% more torque
- For holding on fastening nuts and bolts
- Rust resistant finish

SKU#	LENGTH		BOX/CTN
	mm	inches	
87-430-1	100	4"	6/120
87-431-1	150	6"	6/120
87-432-1	200	8"	6/60
87-433-1	250	10"	6/60
87-434-1	300	12"	6/24
87-435-1	375	15"	4/24
87-371-1	457	18"	2/12

3 CUTTING AND HOLDING TOOLS

Adjustable Wrench



87-796

- Comfortable & anti-slip grip
- For holding on fastening nuts and bolts
- Jaws fully hardened and tempered
- 25% more torque
- Rust resistant finish

SKU#	LENGTH		BOX/CTN
	mm	inches	
87-796	460	18"	1/12
87-797	609	24"	1/6

Pipe Wrench



87-626

- Two-way toothing and spring loaded jaw provide positive grip
- Cast iron handle with drop forged jaw, heat-treated
- Knurled large carbon steel nut

SKU#	LENGTH		MAX JAW OPENING		WEIGHT (kg)	PERFORMANCE UNDER STANDARD TORQUE		BOX/CTN
	mm	inches	mm	inches		TORQUE		
87-620	140	6"	25	0.98"	0.225	169N.M		6/72
87-621	186	8"	34	1.33"	0.38	373N.M		6/36
87-622	248	10"	45	1.77"	0.81	790N.M		6/24
87-623	297	12"	55	2.16"	1.14	1129N.M		6/12
87-624	332	14"	65	2.55"	1.4	1468N.M		6/12
87-625	414	18"	80	3.14"	2.38	2258N.M		2/8
87-626	553	24"	95	3.74"	3.83	3161N.M		1/4
87-627	805	36"	140	5.51"	7.88	5137N.M		1/2

Aluminum Pipe Wrench



84-451

- Offer same durability and ease-of-use found in all STANLEY heavy-duty wrenches
- Min 40% lighter than heavy-duty wrenches
- Easier to maneuver
- Heat-treated steel jaws to ensure maximum durability

SKU#	DESCRIPTION	LENGTH inches	BOX/CTN
84-451	10" Aluminum Pipe Wrench	10"	6/36
84-463	12" Aluminum Pipe Wrench	12"	6/24
84-465	14" Aluminum Pipe Wrench	14"	6/24
84-466	18" Aluminum Pipe Wrench	18"	2/12
84-467	24" Aluminum Pipe Wrench	24"	2/6

Basin Wrench



87-448

- Alloy steel, spring loaded head flops over for loosening and tightening at different angles

SKU#	LENGTH		CAPACITY		BOX/CTN
	mm	inches	mm	inches	
87-448	254	10"	22	7/8"	10/40

3 CUTTING AND HOLDING TOOLS

Cable Cutter



84-258

- Designed for electric cable, copper, aluminum, etc
- Notched jaw holds & cuts cables in a clean & sharp way

SKU#	TYPE	LENGTH inches	MAX CUTTING (mm ²)	BOX/CTN
84-258	10" Cable Cutter	10"	60	6/36
84-629	12" Cable Cutter	12"	125	6/24
84-630	21" Cable Cutter	21"	250	1/10
84-632	32" Cable Cutter	32"	500	1/5

PVC Pipe Cutter



14-442

- Heavy duty PVC Pipe Cutter
- Stainless steel blades
- Heat-treated for durability

SKU#	O / A LENGTH		BOX/CTN
	mm	inches	
14-442	42	1-5/8"	10/40

Tubing Cutter



93-033

- Tubing cutters for cutting copper/plastic tubing

SKU#	O / A LENGTH		BOX/CTN
	mm	inches	
93-033	3 - 16	1/8" - 3/4"	20/200
93-020	3 - 28	1/8" - 1-1/8"	10/60
93-021	3 - 31	1/8" - 1-1/4"	10/60
93-028	6 - 64	1/4" - 2-1/2"	6/36

Replacement Cutting Wheel

- Hardened alloy steel replacement cutting wheels



93-019-0

SKU#	CONTENTS	COMPATIBLE TO-	BOX/CTN
93-016-1	Carded - 2 pcs for plastic pipe	93-028	25/250
93-017-1	Carded - 2 pcs for copper & metal	93-628	25/250
93-019-0	Carded - 2 pcs/card	93-020/021	25/250
93-019-1	Bulk - 10 pcs/card	93-020/021	25/250
93-018-1	Carded - 2 pcs/card	93-033	25/250

3 CUTTING AND HOLDING TOOLS

Professional Tile Cutter



94-809

- For parallel & angled cuts
- Angled cuts from 0° to 45°
- Cuts up to 14mm thick
- With 30cm length of gauge for accurate cuts
- Die casting cutting assembly with ball bearing for tough cutting action
- High quality titanium-coated cutting blades, size at 22x6x2mm, cuts up to 500mm metres long
- The diameter of solid chromed rod: 16mm.
- The width of base: 165mm, the thickness at 1.8mm
- Reinforced steel sheet on the back of base
- Packaging: blow mould case, with color sleeve sheet

SKU#	DESCRIPTION	SIZE inches	BOX/CTN
94-809	Professional Tile Cutter	16"	1/1
94-811	Professional Tile Cutter	24"	1/1

Tile Cutter Wheel Set - 7/8"



94-815

- Size is 22 (diameter of outer circle) x 6 (diameter of inner circle) x 2mm (thickness of blade)
- Hardness is HRA 90.5 to 91 degree
- With 'STANLEY' logo engrave on the body
- Three pieces per set

SKU#	DESCRIPTION	CUTTING LENGTH	BOX/CTN
94-815	Tile Cutter Wheel Set - 3pcs	500m	12/120
94-816	Tile Cutter Titanium Wheel Set - 3pcs	600m	12/120

Cast Steel Bench Vice

- Better Performance
- Better than Iron
- Lightweight compared to Iron



81-602-1

SKU#	DESCRIPTION	SIZE	JAW WIDTH/ MAX OPENING	THROAT DEPTH	N.W. (Kg)	CLAMP FORCE (Kg)	BOX/ CTN
81-600-1	Bench Vice w/ Base	3"	3"/3"	2"	6kgs	1,500kgs	1/1
81-601-1	Bench Vice w/ Base	4"	4"/4"	2-1/4"	7.5kgs	2,500kgs	1/1
81-602-1	Bench Vice w/ Base	5"	5"/5"	2-5/8"	11kgs	3,000kgs	1/1
81-603-1	Bench Vice w/ Base	6"	6"/6"	3"	14.5kgs	3,500kgs	1/1
81-604-1	Bench Vice w/ Base	8"	8"/8"	3-1/2"	20.5kgs	4,500kgs	1/1
81-605-1	Bench Vice w/ Base	10"	10"/10"	4"	25.6kgs	5,500kgs	1/1

3 CUTTING AND HOLDING TOOLS

Tile Cutting Pincer



94-824

- Cuts up to 10mm thick
- High quality cutting blades, YG6X, size at 13 (diameter of outer circle) x 6 (diameter of inner circle) x 1mm (thickness of blade)
- Cuts up to 500 metres long
- Hardness is HRA 90.5 to 91 degree

SKU#	DESCRIPTION	CUTTING LENGTH	THICKNESS		BOX/CTN
			CUTTING CAPACITY	mm	
94-824	Tile Cutting Pincer	500m	10		6/36

Bit Braces



02-110

- Holds shank bit from 1/8" to 7/16"
- Steel clad ball bearing head
- Chrome plated finish for rust resistance
- Available in 10" and 12" sweep

SKU#	O / A LENGTH		CHUCK SIZE		BOX/CTN
	mm	inches	mm	inches	
02-110	255	10"	13	1/2"	6/24
02-112	305	12"	13	1/2"	6/24
02-130	255	10"	16	5/8"	6/24

3 CUTTING AND HOLDING TOOLS

Hand Drill



03-011

- Ideal for rapid drilling of small holes in both wood and metal as well as countersinking screw heads
- Self centering 3-jaw steel chuck with 1/4" and 5/16" capacity
- Double pinion gears for smooth operation

SKU#	O / A LENGTH		CHUCK SIZE		BOX/CTN
	mm	inches	mm	inches	
03-011	305	12"	6	1/4"	6/36
03-608	305	12"	8	5/16"	6/36

Powerbore Bits



04-006

- Fully heat-treated carbon steel
- Brad point feeds evenly – will not pull
- Shank has triangular flats for positive grip in 1/4" and large chucks
- For wood and plastics only
- Max. 3000RPM

SKU#	O / A LENGTH		CHUCK SIZE		BOX/CTN
	mm	inches	mm	inches	
04-006	140	5-1/2"	10	3/8"	6/24
04-008	140	5-1/2"	13	1/2"	12/72
04-010	140	5-1/2"	16	5/8"	12/72
04-012	140	5-1/2"	19	3/4"	12/72
04-014	140	5-1/2"	22	7/8"	12/60
04-016	140	5-1/2"	25	1"	12/60

4 FASTENING TOOLS

LONG REACH, COMFORTABLE AND SECURE

STANLEY® is one of the world's preeminent manufacturers of fastening tools which are indispensable, must-own line of tools in every professional toolbox. This broad category includes four distinct and distinguished tool lines: staplers (manual and electric), hammer tackers, hand "pop" riveters and electric glue guns. There are nearly 2 dozen fastening tools, so if you've got something to fasten down or hold together, STANLEY® has the tool to get the job done right.

Comfort, quality and versatility are the three attributes we engineer into our screwdriver line. STANLEY® screwdriver handles are shaped and sized to provide comfort in the hand and torque at the fastener head. The materials and construction are of the highest quality to resist corrosion, chipping and breaking. And with tips ranging from standard to Phillips® to Torx® to square, STANLEY® screwdrivers cover almost every application.



SCREWDRIVER HANDLES

Handle materials impervious to chemicals

Shape/texturing for grip and mechanical advantage



Tip identification

Small diameter for speed turning

FIXED SCREWDRIVER BARS

TIP

- Forged
- Shoulder grind
- Face grind
- Can be magnetic, black oxide, or blasted

Fully heat treated bar for toughness & strength

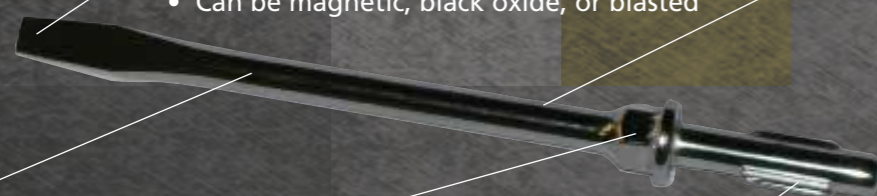

BAR

- Coated to prevent rust
 - Lacquer
 - Black oxide
 - Nickel plate
 - Chrome
- Can be mill finished, tumbled, blasted or polished

BOLSTER

- Allows extra torque to be applied with a wrench when necessary
- Stops bar push-through when struck

WINGS

Two wings are formed in the blade at the handle end: These cut into the hole of the handle when driven in under pressure and prevent the bar turning inside the handle.

TIP DIFFERENCES

SLOTTED TIP DIFFERENCES



SLOTTED Screwdrivers are referred to by their Blade Length and Tip Configuration



Flared Tip : The strongest, for heavy duty

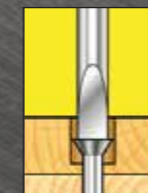

Cabinet Tip : Used when fitting into counter bore

PHILLIPS & POZIDRIV



Referred to by a Number Point smallest = 0 point to largest = 4 point

PHILLIPS
Screws have 4 recessed cross 'slots' tapered conically. Driver Tip has 4 tapered wings separated by 4 hollow flutes.

POZIDRIV (common in Europe)
Screws have 4 recessed parallel cross 'slots' and, also, a square recess at the centre. Driver Tip has 4 straight parallel wings and between each wing is a square-section rib to fit the screw centre.

Phillips® is a registered trademark of Phillips Screw Company
Torx® is a registered trademark of Acument Intellectual Properties, LLC

VDE Screwdriver

- Insulation directly injection-molded around the blade according to EN60900
- Ergonomic, shock resistant, anti slip handle and for greater torque to be applied with less effort
- Each screwdriver is individually tested to 10,000V in a water bath for 10 SCEa
- Hardness and torque values exceed ISO/ DIN standards



SKU#	TYPE	LENGTH		BOX/CTN
		mm	mm	
65-966	Std Parallel	3 x 100	0.5 x 3.0	12/240
65-967	Std Parallel	4 x 100	0.8 x 4.0	12/240
65-968	Std Parallel	5.5 x 125	1.0 x 5.5	12/120
65-969	Std Parallel	6.5 x 150	1.2 x 6.5	12/120
65-970	Std Parallel	8 x 175	1.6 x 10.0	12/120
65-971	Std Parallel	10 x 200	-	12/120
65-972	Phillips®	#0 x 60	-	12/240
65-973	Phillips®	#1 x 80	-	12/120
65-974	Phillips®	#2 x 100	-	12/120
65-975	Phillips®	#3 x 150	-	12/120

VDE Screwdriver 6pc Set with Bonus



65-980

SKU#	CONTENT	BOX/CTN
65-980	6 pc set: VDE Screwdriver Standard Parallel - 3 x 100mm VDE Screwdriver Standard Parallel - 4 x 100mm VDE Screwdriver Standard Parallel - 5.5 x 125mm VDE Screwdriver Standard Parallel - 6.5 x 150mm VDE Screwdriver Philips® - #1 x 80mm VDE Screwdriver Philips® - #2 x 100mm	10/10

Cushion Grip 2 Screwdriver

- Improved ergonomic design for maximum grip and torque
- Ergonomically designed, bi-material handles for maximum comfort and for greater torque to be applied with less effort
- Chrome vanadium blade with tough hardened black oxide tips
- Nickel-plated bar for corrosion resistance
- High quality, heat treated plated bars for lasting "pro" performance and rust resistance



65-157-2

SKU#	TYPE	LENGTH		BOX/CTN
		mm	inches	
65-157-2	Phillips®	#0 x 60	1/8" x 2-3/8" x 0PT	12/72
65-158-2	Phillips®	#0 x 100	1/8" x 4" x 0PT	12/72
65-159-2	Phillips®	#0 x 125	1/8" x 5" x 0PT	12/72
65-160-2	Phillips®	#0 x 150	1/8" x 6" x 0PT	12/72
65-162-2	Phillips®	#1 x 75	3/6" x 3" x 1PT	12/72
65-163-2	Phillips®	#1 x 100	3/6" x 4" x 1PT	12/72
65-164-2	Phillips®	#1 x 150	3/6" x 6" x 1PT	12/72
65-165-2	Phillips®	#1 x 200	3/6" x 8" x 1PT	12/72
65-166-2	Phillips®	#2 x 45	1/4" x 1-1/2" x 2PT	12/72
65-167-2	Phillips®	#2 x 100	1/4" x 4" x 2PT	12/72
65-168-2	Phillips®	#2 x 125	1/4" x 5" x 2PT	12/72
65-169-2	Phillips®	#2 x 150	1/4" x 6" x 2PT	12/72
65-170-2	Phillips®	#2 x 200	1/4" x 8" x 2PT	12/72
65-171-2	Phillips®	#2 x 250	1/4" x 10" x 2PT	12/72
65-172-2	Phillips®	#3 x 150	5/16" x 6" x 3PT	12/72
65-173-2	Phillips®	#3 x 200	5/16" x 8" x 3PT	12/72
65-174-2	Phillips®	#3 x 250	5/16" x 10" x 3PT	12/72



65-180-2

SKU#	TYPE	LENGTH		BOX/CTN
		mm	inches	
65-180-2	Slotted	3 x 75	1/8" x 3"	12/72
65-181-2	Slotted	3 x 100	1/8" x 4"	12/72
65-182-2	Slotted	3 x 125	1/8" x 5"	12/72
65-183-2	Slotted	3 x 150	1/8" x 6"	12/72
65-186-2	Slotted	5 x 75	3/16" x 3"	12/72
65-187-2	Slotted	5 x 100	3/16" x 4"	12/72
65-188-2	Slotted	5 x 150	3/16" x 6"	12/72
65-189-2	Slotted	5 x 200	3/16" x 8"	12/72
65-190-2	Slotted	6.5 x 45	1/4" x 3/4"	12/72
65-191-2	Slotted	6.5 x 100	1/4" x 4"	12/72
65-192-2	Slotted	6.5 x 125	1/4" x 5"	12/72
65-193-2	Slotted	6.5 x 150	1/4" x 6"	12/72
65-194-2	Slotted	6.5 x 200	1/4" x 8"	12/72
65-195-2	Slotted	6.5 x 250	1/4" x 10"	12/72
65-196-2	Slotted	8 x 150	5/16" x 6"	12/72
65-197-2	Slotted	8 x 200	5/16" x 8"	12/72
65-198-2	Slotted	8 x 250	5/16" x 10"	12/72

SKU#	TYPE	LENGTH		BOX/CTN
		mm	inches	
65-227-2	Standard	5 x 100	3/16" x 3"	12/72
65-228-2	Standard	5 x 150	3/16" x 4"	12/72
65-229-2	Standard	5 x 200	3/16" x 6"	12/72



65-144-2

SKU#	TYPE	SIZE	LENGTH		BOX/CTN
			inches	mm	
65-144-2	Torx®	T5 x 80mm	(1/8" x 3-1/8")	1.37	12/72
65-145-2	Torx®	T6 x 80mm	(1/8" x 3-1/8")	1.65	12/72
65-146-2	Torx®	T7 x 80mm	(1/8" x 3-1/8")	1.97	12/72
65-147-2	Torx®	T8 x 80mm	(1/8" x 3-1/8")	2.30	12/72
65-148-2	Torx®	T10 x 80mm	(1/8" x 3-1/8")	2.72	12/72
65-149-2	Torx®	T15 x 80mm	(3/16" x 3-1/8")	3.26	12/72
65-150-2	Torx®	T20 x 120mm	(3/16" x 4-3/4")	3.26	12/72
65-151-2	Torx®	T25 x 120mm	(1/4" x 4-3/4")	4.40	12/72
65-152-2	Torx®	T27 x 120mm	(1/4" x 4-3/4")	4.96	12/72
65-153-2	Torx®	T30 x 120mm	(1/4" x 4-3/4")	5.49	12/72
65-154-2	Torx®	T40 x 120mm	(5/16" x 4-3/4")	6.60	12/72



65-156-2

SKU#	CONTENTS	SIZE	BOX/CTN
65-155-2	Torx® Set 5 pcs	T5, T6, T8, T10, T15 x 80mm	12/12
65-156-2	Torx® Set 6 pcs	T10, T15, x80mm & T20, T25, T30, T40 x 120mm	12/12

Cushion Grip 2 Screwdriver Set



92-002-2

92-004-2



65-242-2

65-199-2

65-200-2

SKU#	CONTENTS	BOX/CTN
92-004-2	8 pc set: Phillips #0 x 60mm Phillips #1 x 100mm Phillips #2 x 45mm Phillips #2 x 150mm Slotted 3mm x 75mm Slotted 5mm x 100mm Slotted 6.5mm x 45mm Slotted 6.5mm x 150mm	12/12
92-002-2	6 pc set with bonus: Phillips #1 x 100mm Phillips #2 x 100mm Phillips #2 x 45mm Slotted 5mm x 100mm Slotted 6.5mm x 100mm Slotted 6.5mm x 45mm Free: Digital Test Pen (AN-100)	12/12
65-242-2	6 pc set: Phillips #1 x 100mm Phillips #2 x 150mm Std Parallel 5mm x 100mm Std Parallel 5mm x 150mm Slotted 6.5mm x 150mm Slotted 5mm x 100mm	12/12
65-199-2	4 pc set: Phillips #1 x 100mm Phillips #2 x 150mm Std Parallel 5mm x 100mm Slotted 6.5mm x 150mm	24/24
65-200-2	2 pc set: Phillips #2 x 100mm Slotted 6.5mm x 100mm	24/24



68-012

6 Way Screwdriver™

- All-in-one screwdriver with 6 tips: #1 and #2 Phillips®, 1/4" and 3/16" Slotted, 1/4" and 5/16" Nut Driver
- Convenient and space saving, ideal for kitchen drawer or car – no need for extra screwdrivers
- Ergonomically designed bi-material handle for superb comfort
- Tri-lobe shape fits hand comfortably
- Soft, diamond textured handle provides a firm grip for extra torque without strain
- Bar is chrome plated for rust resistance.
- Attach wrench to bolster nut for additional leverage and torque
- High quality bits for long life
- Available in an attractive 24 piece merchandiser
- Slip resistant rubber grip provides comfort

SKU#	CONTENTS	O / A LENGTH		BOX/CTN
		mm	inches	
68-012	1/4", 3/9" Slotted 1PT, 2PT, Phillips® 1/4", 5/6" Nut Driver	7.75	196.9"	6/24

Cushion Grip Multi Bits 2-Way



65-201

- Bi-Material Handle for comfortable grip
- Larger handles for greater torque
- Chrome plated bars for rust resistant
- Magnetized Tips

SKU#	CONTENTS	O / A LENGTH		BOX/CTN
		mm	inches	
65-201	Slotted 6mm x 100mm Phillips #2 x 100mm	6 x 100	1/4" x 4"	12/72
		#2 x 100	#2 x 4"	



3-WAY AUDIBLE RATCHET

68-010

10-Piece Multi-Bit Ratcheting Screwdriver

- Bit storage system for easy visibility, access and security
- Magnetic bit holder for quick, secure change-over of bits
- Top quality, three-position audible ratcheting mechanism; forward, reverse and fixed for lifelong efficiency
- Supplied with 10 bits to suit a wide variety of purposes

SKU#	CONTENTS	O / A LENGTH		BOX/CTN
		mm	inches	
68-010	Ratcheting screwdriver c/w 10 bits 1&2PT – Philip/POZI/Robertson 5&6.5mm slotted T10 & T15 Torx	254	10"	6/36

Screwdriver Insert Bit Set

- Made from chrome vanadium steel
- Recommended for manual applications in multi-bit screwdrivers



68-070



68-071



68-072



68-075

SKU#	CONTENTS	INDIVIDUAL PRODUCT			BOX/CTN
		length	width	height	
68-070	9 pc set: Phillips #1,#2,#3,PZ2,S2 Slotted 3/16",1/4",5/16"	21.2"	16.4"	1.5"	6/36
68-071	29 pc set: Phillips #1,#2,#2,#3,PZ1,PZ2,PZ3,S2 Slotted 6/8",8/10",10/12" Torx T5,T20,T25, T30 Hex 3/32",1/8",5/32",S1,S2,S3 Nutdriver 3/16",1/4",5/16",11/32",3/8", Bit Hold	21.2"	15"	2"	6/48
68-072	33 pc set: 6.35mm / 1/4" 1pc 2-3/8" bits holder Phillips 2x#0,3x#1,3x#2,1x#3 Slotted 5-6,6-8,8-10,10-12 POZI 0,1,2,3 Star T10-15- 20-25-30-40 Square S1,S2,S3 Hex 1/8", 3/32", 5/32", 3/16", 7/32",1/4"	21.2"	22.4"	3.4"	6/48
68-075	36 pc set: Phillips #1,#1,#2,#2,#3,PZ0,PZ1,PZ1,PZ2,P2, PZ3,S0,S1,S1,S2,S2,S3 Slotted 1/8",3/16",1/4",7/32" Torx T10,T15, T20a,T25,T27,T30 Hex 1/16", 1/8",5/32",3/16",7/32",1/4"	21.2"	15"	3.2"	6/36

9 Way Screwdriver™

- 9 tips for all access
- Convenient & space saving
- Ergonomically designed bi-material handle
- Bar is chrome plated for rust resistance
- 10pc Cushion Grip Driver Set :
- 3pc Philip #0, #1, #2, 3 pcs Standard 1/8", 3/16", 1/4", 1 Awl, 1 Tack Puller, 1 Hook Driver
- BOX/CTN: 6/24



62-511



SKU#	CONTENTS	BOX/CTN
62-511	9 Way Interchangeable Screwdriver 10pc Cushion Grip Driver Set: 3pc Phillips® - #0, #1, #2 3pc Standard - 1/8", 3/16", 1/4" 1 Awl - 1 pc 1 Tack Puller - 1pc 1 Hook Driver - 1pc	6/24

6-Piece Bi-Material Handle Precision Screwdriver Set



66-052

66-039

- Attractive bi-material handles designed for easy and comfortable grip
- Chrome vanadium steel bars in black oxide finished with hardened tips - HRC 53
- Comes in 6 popular sizes

SKU#	CONTENTS	BOX/CTN
66-052	0 & 1 pt Phil, 1.4, 2, 2.4, 3mm Standard	12/72
66-039	0 & 1 pt Phil, 1.4, 2, 2.4, 3mm Standard	12/72

Spark Detecting Screwdriver



66-119 & 66-120

- Test range of 100~500V
- Pocket size model c/w clip
- Attractive PP card packaging

SKU#	BLADE LENGTH		O / A LENGTH		TIP WIDTH		BOX/CTN
	mm	inches	mm	inches	mm	inches	
66-119	50	2-3/4"	127	5-1/2"	3	1/8"	20/600
66-120	100	4"	178	7-1/2"	5	3/16"	20/480

Multifunctional Digital Tester With LCD Display and Neon Lamp Display NEW



66-133

- Easy single button operation
- Easy to read & practical screen
- Ergonomic design & shape , Bi-Material body combination
- Pocket clip for easy carrying
- Neon lamp for electriciferous test
- International standard, CE certified
- Rubber hands provides comfort & insulation

SKU#	DESCRIPTION	BOX/CTN
66-133	Multifunctional Digital Tester with LCD Display and Neon Lamp Display	12/96

Multifunctional Digital Tester With LCD Display NEW



66-137

- Induction test, break-point & voltage reading button
- Easy to read & practical screen
- Pocket clip for easy carrying
- International standard, CE certified
- Longer tip for deep insertion

SKU#	DESCRIPTION	BOX/CTN
66-137	Multifunctional Digital Tester with LCD Display	12/240

100 Plus® Cabinet Tip Screwdriver



66-182

- For cabinet building and other precision woodworking

SKU#	BLADE DIAMETER	BLADE LENGTH	OVERALL LENGTH	TIP WIDTH	BOX/CTN
66-182	5mm, 3/16"	305mm, 12"	400mm, 15-3/4"	5mm, 3/16"	6/24

Hex Key Set

SKU#	DESCRIPTION	CONTENTS	BOX/CTN
69-261	Hex Key Set 7pc Fldg MM	1.5/2/2.5/3/4/5/6 mm	12/72
69-262	Hex Key Set 7pc Fldg MM	2.5/3/4/5/6/8/10 mm	12/48
69-251	Hex Key Set 8pc S/arm MM	1.0/1.5/2/2.5/3/4/5/5.5/6 mm	12/72
69-119	Hex Key Set 9pc Chrome MM	1.5/2/2.5/3/4/5/6/8/10 mm – Ball tips	6/36
69-256	Hex Key Set 9pc L/arm MM	1.5/2/2.5/3/4/5/6/8/10 mm – Ball tips	6/36
69-213	Hex Key Set 10pc Ring MM	1.5/2/2.5/3/4/5/5.5/6/8/10 mm	12/72
69-253	Hex Key Set 10pc S/arm MM	1.5/2/2.5/3/4/5/5.5/6/8/10 mm	12/72
69-260	Hex Key Set 5pc Fldg IMP	3/16, 7/32, 1/4, 5/16, 3/8	12/48
69-252	Hex Key Set 8pc S/arm IMP	1/16, 5/64, 3/32, 1/8, 5/32, 3/16, 7/32, 1/4"	12/72
69-259	Hex Key Set 9pc Fldg IMP	5/64, 3/32, 7/64, 1/8, 9/64, 5/32, 3/16, 7/32, 1/4"	12/72
69-230	Hex Key Set 10pc Ring IMP	1/16, 5/64, 3/32, 1/8, 5/32, 3/16, 7/32, 1/4, 5/16, 3/8"	12/72
69-254	Hex Key Set 10pc S/arm IMP	1/16, 5/64, 3/32, 1/8, 5/32, 3/16, 7/32, 1/4, 5/16, 3/8"	12/72
69-257	Hex Key Set 12pc L/arm IMP	1/16, 5/64, 3/32, 7/64, 1/8, 9/64, 5/32, 3/16, 7/32, 1/4, 5/16, 3/8" – Ball tips	6/36
69-263	Hex Key Set 8pc Fldg Torx®	T9/ T10/ T15 / T20/ T25/ T27 T30/ T40	12/72



Tank Thru Screwdriver

- 4 different sizes of handles
- Easy color differentiation: yellow for standard screwdriver, black for Phillips®
- Heavy-duty purpose
- Material: Chrome vanadium hardness : 56-62
- Anti-slip design handle
- 18% bigger impact surface



65-243-1



65-245-1

SKU#	DESCRIPTION	Blade Tip	SIZE	
			Blade Dia. x Length	BOX / CTN
65-243-1	Tank Thru Screwdriver	5mm x 4" (100mm)	Std 0.76 x 4.76	12/180
65-244-1	Tank Thru Screwdriver	5mm x 6" (150mm)	Std 0.76 x 4.76	12/180
65-247-1	Tank Thru Screwdriver	6mm x 4" (100mm)	Std 0.94 x 6.35	12/120
65-248-1	Tank Thru Screwdriver	6mm x 5" (125mm)	Std 0.94 x 6.35	12/120
65-249-1	Tank Thru Screwdriver	6mm x 6" (150mm)	Std 0.94 x 6.35	12/120
65-253-1	Tank Thru Screwdriver	8mm x 6" (150mm)	Std 1.07 x 7.94	12/72
65-254-1	Tank Thru Screwdriver	8mm x 8" (200mm)	Std 1.07 x 7.94	12/72
65-255-1	Tank Thru Screwdriver	8mm x 10" (250mm)	Std 1.07 x 7.94	12/72
65-256-1	Tank Thru Screwdriver	8mm x 12" (300mm)	Std 1.07 x 7.94	12/72

SKU#	DESCRIPTION	Blade Tip	SIZE	
			Blade Dia. x Length	BOX / CTN
65-245-1	Tank Thru Screwdriver	5mm x 4" (100mm)	Phil 1PT	12/180
65-246-1	Tank Thru Screwdriver	5mm x 6" (150mm)	Phil 1PT	12/180
65-250-1	Tank Thru Screwdriver	6mm x 4" (100mm)	Phil 2PT	12/120
65-251-1	Tank Thru Screwdriver	6mm x 5" (125mm)	Phil 2PT	12/120
65-252-1	Tank Thru Screwdriver	6mm x 6" (150mm)	Phil 2PT	12/120
65-257-1	Tank Thru Screwdriver	8mm x 6" (150mm)	Phil 3PT	12/72
65-258-1	Tank Thru Screwdriver	8mm x 8" (200mm)	Phil 3PT	12/72
65-259-1	Tank Thru Screwdriver	8mm x 10" (250mm)	Phil 3PT	12/72
65-260-1	Tank Thru Screwdriver	8mm x 12" (300mm)	Phil 3PT	12/72

T-Handle Hex Key

- 2 way T-handle features two drive ends: both top & bottom
- Ball point feature provides greater strength & enable all angle operation
- Attractive color for easy recognition



69-279



69-300



69-289

SKU#	DESCRIPTION	SIZE	BOX/CTN
69-277	2-Way T-handle Ball-Point Hex Key - Yellow	2.0mm	12/72
69-278	2-Way T-handle Ball-Point Hex Key - Yellow	2.5mm	12/72
69-279	2-Way T-handle Ball-Point Hex Key - Yellow	3.0mm	12/72
69-280	2-Way T-handle Ball-Point Hex Key - Yellow	4.0mm	12/72
69-281	2-Way T-handle Ball-Point Hex Key - Yellow	5.0mm	12/72
69-282	2-Way T-handle Ball-Point Hex Key - Yellow	6.0mm	12/48
69-283	2-Way T-handle Ball-Point Hex Key - Yellow	7.0mm	12/48
69-284	2-Way T-handle Ball-Point Hex Key - Yellow	8.0mm	12/48
69-285	2-Way T-handle Ball-Point Hex Key - Yellow	10.0mm	12/48

SKU#	DESCRIPTION	SIZE	BOX/CTN
69-298	2-Way T-handle Torx Key - Grey	T7	12/72
69-299	2-Way T-handle Torx Key - Grey	T8	12/72
69-300	2-Way T-handle Torx Key - Grey	T9	12/72
69-301	2-Way T-handle Torx Key - Grey	T10	12/72
69-302	2-Way T-handle Torx Key - Grey	T15	12/72
69-303	2-Way T-handle Torx Key - Grey	T20	12/72
69-304	2-Way T-handle Torx Key - Grey	T25	12/72
69-305	2-Way T-handle Torx Key - Grey	T27	12/72
69-306	2-Way T-handle Torx Key - Grey	T30	12/72
69-307	2-Way T-handle Torx Key - Grey	T40	12/48
69-308	2-Way T-handle Torx Key - Grey	T45	12/48

SKU#	DESCRIPTION	SIZE inches	BOX/CTN
69-286	2-Way T-handle Ball-Point Hex Key - Black	5/64"	12/72
69-287	2-Way T-handle Ball-Point Hex Key - Black	3/32"	12/72
69-288	2-Way T-handle Ball-Point Hex Key - Black	7/64"	12/72
69-289	2-Way T-handle Ball-Point Hex Key - Black	1/8"	12/72
69-290	2-Way T-handle Ball-Point Hex Key - Black	9/64"	12/72
69-291	2-Way T-handle Ball-Point Hex Key - Black	5/32"	12/72
69-292	2-Way T-handle Ball-Point Hex Key - Black	3/16"	12/72
69-293	2-Way T-handle Ball-Point Hex Key - Black	7/32"	12/72
69-294	2-Way T-handle Ball-Point Hex Key - Black	1/4"	12/48
69-295	2-Way T-handle Ball-Point Hex Key - Black	5/16"	12/48
69-296	2-Way T-handle Ball-Point Hex Key - Black	3/8"	12/48

GluePro™ Mini Hot Melt Glue Gun



69-GR10B

- Small, portable size for quick gluing jobs in tight spaces
- Trigger-feed mechanism controls glue flow
- Uses GS10DT standard mini hot melt sticks
- Fold-out stand for safe, handy storage while in use

SKU#	CONTENTS	GLUE STICK	BOX/CTN
69-GR10B	Mini Hot Melt Glue Gun 100-240V/15W Round Pin	GS10DT	6/36
69-GR10C	Mini Hot Melt Glue Gun 100-240V/15W Flat Pin	GS10DT	6/36

GluePro™ Mini Dual Temp Melt Glue Gun



69-GR15C

- Ideal for hobbies, crafts and repairs
- Convenient, one-touch high/low selector switch
- Uses mini dual-temperature glue on both settings and mini hot-melt on high settings
- Fold-out stand for safe, handy storage while in use

SKU#	CONTENTS	GLUE STICK	BOX/CTN
69-GR15B	Mini Dual Temp Glue Gun 100-240V/15W Round Pin	GS10DT	6/36
69-GR15C	Mini Dual Temp Glue Gun 100-240V/15W Flat Pin	GS10DT	6/36

GluePro™ Trigger Feed Hot Melt Glue Gun



69-GR20B

- Quality engineered for reliable performance
- Trigger-feed mechanism controls glue flow
- Heats up quickly and bonds within 60 seconds
- Uses standard GS10DT hot melt glue sticks
- Fold-out stand for safe, handy storage while in use

SKU#	CONTENTS	GLUE STICK	BOX/CTN
69-GR20B	Trigger Feed Hot Melt Glue Gun 100-240V/40W Round Pin	GS20DT/25DT/ GS260 &500	6/24
69-GR20C	Trigger Feed Hot Melt Glue Gun 100-240V/40W Flat Pin	GS20DT/25DT/ GS260 &500	6/24



69-GR25B

GluePro™ Trigger Feed Dual Melt Glue Gun

- Offers the versatility of high and low temperature gluing in one gun
- Convenient, one-touch high/low selector switch
- Uses standard dual-temperature glue on both settings and hot melt formulas on high setting
- Heats up quickly and bonds within 60 seconds
- Fold-out stand for safe, handy storage while in use

SKU#	CONTENTS	GLUE STICK	BOX/CTN
69-GR25B	Trigger Feed Dual Melt Glue Gun 100-240V/80W Round Pin	GS20DT/25DT/ GS260 &500	6/24
69-GR25C	Trigger Feed Dual Melt Glue Gun 100-240V/80W Flat Pin	GS20DT/25DT/ GS260 &500	6/24



69-GR90B

GluePro™ Cord Free 2-Way Glue Gun

- Versatile glue gun works with or without cord
- Cordless operation for up to 12 minutes
- Heats up quickly
- Fold-out stand for safe, handy storage while in use

SKU#	CONTENTS	GLUE STICK	BOX/CTN
69-GR90B	Cord Free 2 Way Glue Gun 100-240V/40W Round Pin	GS20DT/25DT/ GS260 &500	6/24
69-GR90C	Cord Free 2 Way Glue Gun 100-240V/40W Flat Pin	GS20DT/25DT/ GS260 &500	6/24

Dual Temp 4" Mini Glue Stick

- For use in mini hot melt, low temperature, and dual temperature glue guns
- Excellent for bonding heat sensitive materials, as well as general applications



GS10DT

SKU#	LENGTH		FOR	PACK(BOX)	BOX/CTN
	mm	inches			
GS10DT	100 x 7.1	4" x 0.28"	GR10, GR15 glue guns	24 pcs	5/60



GS25DT

Dual Temp 4" Glue Stick

- For use in mini hot melt, low temperature, and dual temperature glue guns
- Excellent for bonding heat sensitive materials, as well as general applications
- Standard diameter glue sticks in 4" length

SKU#	LENGTH		FOR	PACK(BOX)	BOX/CTN
	mm	inches			
GS20DT	100 x 11.3	4" x 0.45"	GR20, GR25 & GR90	24 pcs	5/60
GS25DT	254 x 11.3	10" x 0.45"	GR20, GR25 & GR90	12 pcs	5/50



GS260

Woodworking 4" Glue Stick

- Hot Melt Formula for woodworking jobs
- Standard diameter glue sticks in 4" length

SKU#	LENGTH		FOR	PACK(BOX)	BOX/CTN
	mm	inches			
GS260	100 x 11.3	4" x 0.45"	GR20, GR25 & GR90	6 pcs	5/60



GS500

Formula II - Super Strength 4" Glue Stick

- Extra strength adhesive
- Standard diameter glue sticks in 4" length

SKU#	LENGTH		FOR	PACK(BOX)	BOX/CTN
	mm	inches			
GS500	100 x 11.3	4" x 0.45"	GR20, GR25 & GR90	6 pcs	5/60



83-122

Bailey® Heavy-Duty Corner Clamp

- Articulating design allows for work pieces of equal or varying thickness to be joined at right angles
- Patent-pending reversible head design allows for use as a parallel clamp
- Comfort and maximum torque achieved with bi-material, tri-lobular handle
- Mounting holes allow clamp to be securely attached to work surface
- Heavy-duty, cast-zinc construction for durability

SKU#	LENGTH		BOX/CTN
	mm	inches	
83-122	57	2-1/4"	2/12

MaxSteel™ C-Clamp



83-031K

- High-visibility, corrosion-resistant finish
- Advanced frame design resists flexing and bending
- Heavy-duty, malleable iron and steel construction
- Roll-formed screw threads ensure smooth operation and durability
- Oversized "T" handle for extra torque

SKU#	LENGTH		BOX/CTN
	mm	inches	
83-031K	30 x 25	1" x 1-3/16"	12/72
83-032K	33 x 50	2" x 1-5/16"	12/72
83-033K	57 x 75	3" x 2-1/4"	6/36
83-034K	75 x 100	4" x 3"	6/24
83-035K	89 x 150	6" x 3-1/2"	6/12
83-036K	100 x 200	8" x 4"	3/6

Soldering Iron



69-033C

- Suitable for soldering metals like copper, tin, brass and stained glass
- Working temperature reached in 2 minutes
- Slim pencil like handle for easy use and control

SKU#	PIN HEAD	CAPACITY	BOX/CTN
69-031B	Round	30W/220V	20/80
69-031C	Flat	30W/220V	20/80
69-033B	Round	45W/220V	20/80
69-033C	Flat	45W/220V	20/80

Soldering Gun



69-041B

- Suitable for soldering light gauge wires, thin metals and hobby work
- Reaches working temperature in 12 seconds
- Come with 2 soldering tips

SKU#	CONTENTS	PIN HEAD	BOX/CTN
69-041B	100W/220V Complete kit comprising: Soldering gun, Tip Solder	Round	6/24
	100W/220V Complete kit comprising: Soldering gun, Tip Solder	Flat	6/24



69-646



69-799

Riveter

- 69-799 body is nickel-plated
- Versatile tool for joining sheet metal, fabric, leather, plastic parts, etc
- Spring loaded handle ejects rivets stem
- All steel body with non-slip grip and wrench for changing nosepieces

SKU#	CONTENTS	BOX/CTN
69-646	Medium-duty riveter c/w 3 nosepieces for 1/8", 5/32", 3/16" rivets	5/30
69-799	Heavy-duty riveter c/w 4 nosepieces for 3/32", 1/8", 5/32", 3/16" rivets	6/24

Swivel Head Riveter



MR77C

- 360° rotating head, makes it easy to apply rivets in tight spaces
- Rugged die-cast metal construction for long life
- Extra nose pieces and wrench are conveniently stored in handle
- Long handle makes riveter easy to squeeze

SKU#	DESCRIPTION	BOX/CTN
MR77C	Swivel Header Riveter	6/24

Light-Duty Staple Gun



TR45

TR110

- Perfect for everyday stapling needs around the home or office
- Lightweight with convenient handle lock for safe storage
- Quick-jam-clear mechanism saves time and hassles
- Chrome-plated steel construction for durability

SKU#	STAPLE USED	BOX/CTN
TR45	TRA200 or Arrow® JT-21® light-duty staples	40/720
TR110	SharpShooter® TRA700 or ArrowT-50® heavy-duty staples	1/3



TR150



TR150HL

Heavy-Duty Staple Gun

- Easy-squeeze handle reduces hand fatigue
- Anti-jam mechanism saves time on the job
- High-visibility yellow color easy to spot in a toolbox or workshop
- Durable aircraft-aluminum housing withstands heavy use
- Delivers high power and deep penetration
- Easy-slide full-stick staple load

SKU#	STAPLE USED	BOX/CTN
TR150	SharpShooter® TRA700 or Arrow® T-50® heavy-duty staples	1/6
TR150HL	SharpShooter® TRA700 series or Arrow® T-50® heavy-duty staples	1/6



95-063

2- in-1 Staple & Brad Nail Gun

- Hi-impact plastic housing
- Durable working parts
- Includes working parts
- Bottom loading for easy jam clearing
- Safety handle lock

SKU#	STAPLE USED	BOX/CTN
95-063	6mm - 10mm, 18 Gauge, 10mm, Brad Nail	12/24

Heavy-Duty Staple Gun / Brad Nailer



TR250

- Easy-squeeze product works overtime as a staple gun, brad-nailer, cable-tacker and wire-tacker
- All-metal drive channel ensures better penetration
- Less force to squeeze and more driving power
- Heavy-duty aircraft-aluminum housing for long-lasting durability
- Hi/Lo power lever for hard and soft materials
- Flush-nose design solves the problem of stapling in tight spots
- Lock-down handle for safe storage
- Quick-view window simplifies staple identification
- Easy-slide full-stick staple load

SKU#	STAPLE USED	BOX/CTN
TR250	SharpShooter® TRA700 series or Arrow® T-50® heavy-duty narrow crown staples and 1/2", 9/16" and 5/8" Brads	1/6



CT10X

Cable Tacker 2-in-1 Staple Gun

- 30% easier to squeeze than leading competitor
- Patented Anti-jam mechanism
- Hi/Lo power adjustment
- Lightweight Aircraft Aluminum housing
- Built-in wire guide prevents stapling into the wire
- Quick drop-in staple loading
- Narrow front allows stapling in tight spaces
- Comfort soft grip handle with lock

SKU#	STAPLE USED	BOX/CTN
CT10X	CT106 STAPLES 10MM U-TYPE Takes both round crown and flat crown staples	1/6

Staples For CT10X

10MM CABLE STAPLES, 1000PK	
Staple Type:	Cable
Bore Diameter Nom:	10mm
Leg Length:	10mm



CT306

- For heavy-duty stapling jobs
- Galvanized to reduce corrosion
- Color-coded packaging makes size and product selection a cinch
- Sturdy plastic packaging reduces staple breakage
- Fits Arrow® T2025

SKU#	DESCRIPTION	BOX/CTN
CT305	STAPLES 5/6" (8MM) FOR CT10X	6/48
CT306	STAPLES 3/8" (10MM) FOR CT10X	5/40
CT106	STAPLES (10MM) FOR CT10X (4 Type)	6/48

Heavy-Duty Hammer Tacker



PHT150

- Used for fast installation of carpeting, roofing materials or insulation
- Contractor-quality design
- Full-rubber grip absorbs shock and protects hand
- Heavy-duty steel construction for added durability
- Loads two full sticks of STANLEY® SharpShooter® TRA700 or Arrow® T-50® heavy-duty staples (1/4"-3/8")

SKU#	STAPLE USED	BOX/CTN
PHT150	Loads two full sticks of STANLEY® SharpShooter® TRA700 or Arrow® T-50® heavy-duty staples (1/4"-3/8")	1/6



PHT250

Heavy-Duty Hammer Tacker

- Durable all-steel construction withstands heavy use
- Contractor-quality heavy-duty steel construction
- Safety-grip handle guards against hand fatigue and injury

SKU#	STAPLE USED	BOX/CTN
PHT250	Loads two full sticks of STANLEY® SharpShooter® TRA700 or Arrow® T-50® heavy-duty staples (5/16" - 1/2")	8/48



PHT350

FatMax™ EXTREME Heavy-Duty Hammer Tacker

- Professional grade Heavy-Duty Hammer Tacker with an auto retractable built in blade
- Extendable blade that retracts when not in use – easy and secure
- Blade release allows user to remove blade with the push of a button
- Professionals can staple down roofing paper with the Hammer Tacker and then cut away any excess materials with the blade
- Housing design secures blade, allows for easy removal, and replacement of blade
- Features bottom loading - faster and easier to load staples
- Staple exit with patented anti-jam technology
- The PHT350 Hammer Tacker with blade comes with 3 free blades. Uses STANLEY® 11-921, 11-937 or 11-987 blades

SKU#	STAPLE USED	BOX/CTN
PHT350	Loads two full sticks of STANLEY® SharpShooter® TRA700 or Arrow® T-50® heavy-duty staples (5/16" - 1/2")	12/48

SharpShooter™ Staple

- For light-duty household and crafting stapling jobs
- Colour-coded packaging makes size and product selection a cinch
- Sturdy plastic packaging reduces staple breakage
- Light-Duty - Narrow Crown - fits TR45 and Arrow® JT-21
- Heavy-Duty - Narrow Crown - fits TR110, TR200, TRE500 Series, PHT150, PHT250 and Arrow® T-50



TRA705T

SKU#	DESCRIPTION	HEIGHT		PACK SIZE	BOX/CTN
		mm	inches		
TRA204	1/4" Light-Duty Staples	6	1/4"	1,000 pcs	7/56
TRA205	5/16" Light-Duty Staples	8	5/16"	1,000 pcs	6/48
TRA206	3/8" Light-Duty Staples	10	3/8"	1,000 pcs	5/40

SKU#	DESCRIPTION	HEIGHT		PACK SIZE	BOX/CTN
		mm	inches		
TRA704T	1/4" Heavy-Duty Staples	6	1/4"	1,000 pcs	7/56
TRA705T	5/16" Heavy-Duty Staples	8	5/16"	1,000 pcs	6/48
TRA706T	3/8" Heavy-Duty Staples	10	3/8"	1,000 pcs	5/40
TRA708T	1/2" Heavy-Duty Staples	12	1/2"	1,000 pcs	4/32
TRA709T	9/16" Heavy-Duty Staples	14	9/16"	1,000 pcs	4/32

STAPLE SELECTION GUIDE		SUITABLE FOR STAPLERS				
Staples	Size	TR250	TR150HL	TR150	TR110	TR45
		Heavy-Duty Staples				
TRA704T	1/4"	•	•	•	•	
TRA705T	5/16"	•	•	•	•	
TRA706T	3/8"	•	•	•	•	
TRA708T	1/2"	•	•	•	•	
TRA709T	9/16"	•	•	•	•	
Light-Duty Staples						
TRA204	1/4"					•
TRA205	5/16"					•
TRA206	3/8"					•

STAPLE SELECTION GUIDE		SUITABLE FOR HAMMER TACKER		
Staples	Size	PHT350	PHT250C	PHT150C
		Heavy-Duty Staples		
TRA705T	5/16"	•	•	•
TRA706T	3/8"	•	•	•
TRA708T	1/2"	•	•	

5 STRIKING AND STRUCK TOOLS

POWERFUL, QUALITY AND ADVANCE

STANLEY®'s world-renown and world-class research and development teams design hammers that not only exceed customers' expectations, but also live up to the proud STANLEY® name. And in its state-of-the-art manufacturing facilities, STANLEY® produces hammers made from the finest materials available, including wood, fiberglass, steel and graphite. At STANLEY®, every hammer is engineered with safety in mind. That's why you'll find shock absorption features on many of our striking tools. You'll also find balanced heads, ergonomically-designed grips and handles shaped to prevent slipping. You can be confident that STANLEY® hammers exceed the industry standard for safety and durability.



WHY STANLEY® HAMMER?

- 1 Superior quality**
10 extensive tests to ensure the best quality on the market
 - Pound Test
 - Handle Bend Test
 - Head Pull Test
- 2 Technology**
 - STANLEY® is the only hammer that is rim tempered to reduce spalling
 - Patent Pending 70%+ Large strike face for striking accuracy
 - Patented AntiVibe® reduces damaging vibrations
 - Patented Stabilizers reduce arm twisting torsion

USE THE RIGHT WEIGHT OF HAMMER

Choosing the right weight is important, because there is no benefit in lifting a 22oz hammer to drive nails no longer than 50mm (2"). In the same way a 16oz hammer will make heavy work in driving a 75mm nail. As a reasonable compromise a 20oz claw hammer is a good general-purpose choice.

HAMMER TERMINOLOGY



HAMMER END USER CUES

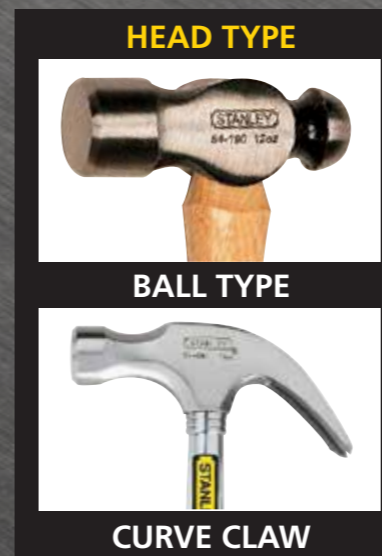

- 1 Head Type**
 - Curve Claw = DIY
 - Ball Pein = Pro
 - 10 Specialty Head Types = Pro, Advanced DIY
- 2 Handle Length**
 - < 14" = DIY and Pro
 - > 14" = Pro (Framing)
- 3 Durability**
 - 2pc = Wood, Fiberglass, Graphite, Steel & Titanium
 - 1pc = Steel and Titanium
- 4 Weight**
 - DIY = 7oz, 13oz, 16oz
 - Pro = 16oz, 20oz, 22oz, 28oz
- 5 Grip Feel**
- 6 Balance**
- 7 Face**
 - Smooth
 - Checked

FatMax™ Functional Utility Bar



55-119R



- Multifunction usage
- Tough and versatile tool
- 4-in-1 tool for prying, splitting, board bending and striking jobs
- 2.5 lbs - fits easily in the hammer loop and easy to swing
- One piece forged steel bar for increased durability
- Board grabbing jaw sized for 2x lumber
- Beveled nail slot for pulling & prying nails
- Serrated gripping jaw, textured grip for excellent comfort & control, even when wet
- The short and light weight lends itself to coping with harder to reach corners
- Tempered steel that prevents chipping

SKU#	DESCRIPTION	LENGTH		WEIGHT		BOX/CTN
		inches	mm	lbs	kg	
55-119R	FatMax™ Functional Utility Bar	15"	381	2.5lbs	1.13	2/20

FatMax™ Xtreme® FuBar® Utility Bar - 18"



55-099

- Recipient of Popular Science "Best of What's New" Award.
- Utility bar for heavy demolition work
- 4-in-1 tool for prying, splitting, board bending and striking jobs
- One-piece forged steel bar for durability
- Board-grabbing jaw sized for 2X lumber
- Beveled nail slot for pulling and prying nails
- Textured grip for excellent comfort and control
- Heat-treated and tempered striking face helps prevent chipping
- High-visibility powder-coated finish

SKU#	DESCRIPTION	LENGTH		WEIGHT		BOX/CTN
		inches	mm	lbs	kg	
55-099	FatMax™ Xtreme® FuBar® Utility Bar Blade Width 1-1/2" / 38mm	18"	457	4lbs	1.81	2/2

FatMax™ Xtreme® Functional Utility Bar III



55-120R

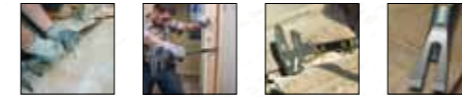

- The ultimate multi-purpose demolition tool
- Excellent for prying, splitting, board bending & heavy striking jobs
- Superior leverage with its 30" length
- 8.5 lb total weight is precision balanced for maximum striking power
- Sledge hammer face
- Ripping hook
- One piece forged steel construction for increased durability
- Textured grip for excellent control and comfort
- Nail puller & pry bar

SKU#	DESCRIPTION	LENGTH		WEIGHT		BOX/CTN
		inches	mm	lbs	kg	
55-120R	FatMax™ Xtreme™ Functional Utility Bar III	30"	762	8.5lbs	3.85	1/6

STANLEY® Fubar® Forcible Entry Tool - 18"

Our premier forcible entry tool designed by responders for vehicle extrication and extreme demolition:



55-121

- 8-in-1 tool for prying, splitting, board bending and striking jobs
 - Demolition head
 - Gas shut-off feature
 - Spanner wrench
 - Pry bar for ripping
 - Hydrant wrench
 - 2nd tier board jaw also fits square hydrant nuts
 - Board jaw sized specifically for grabbing common dimensional lumber
 - Beveled nail slot for pulling & prying nails
- One piece forged steel bar for increased durability
- Heat treated and tempered striking face prevents chipping
- Heat-resistant grips are durable and lightweight
- Carabiner holes for easy attachment of shoulder strap
- Hi-visibility 3M™ Scotchlite™ enhances visibility

SKU#	DESCRIPTION	LENGTH	WEIGHT	BOX/CTN
55-121	FUBAR WITH NYLON GRIP 18"	18",457.2mm	6 lbs, 2.72 kilos	4/4
55-122	FUBAR WITH NYLON GRIP 30"	30",762mm	11 lbs, 4.99 kilos	2/2

Mallet Hammer



56-112



TIP



MALLET

- Plastic tips on this hammer are designed to wear away as they protect the surface being struck
- Replacement is as easy as unscrew off the old tip and screw on the new one
- Forged, high carbon, quality steel head

SKU#	MALLET HEAD LENGTH		BOX/CTN
	mm	inches	
56-112	0.8	22"	6/60
56-113	1.1	28"	6/36
56-114	1.3	35"	6/36
56-115	1.7	45"	6/24
56-116	2.3	60"	4/16

FatMax® Xtreme™ AntiVibe® Curve Claw Nailing Hammer



51-162

- 75% larger* strike face for improved striking accuracy
- AntiVibe® technology minimizes vibration and shock at impact
- Torsion control stabilizers reduce arm-twisting fatigue
- Magnetic Nail Start feature for extended reach for one-handed nailing
- Exclusive rim temper reduces incidences of chipping or spalling
- Forged, one-piece steel construction for strength and durability
- Slip-resistant handle for a secure grip and comfort
- Precision balanced, curved claw, smooth face

*Than traditional hammers

Overall Length 13-1/2" / 343mm

SKU#	HEAD LENGTH		WEIGHT		BOX/CTN
	mm	inches	grams	oz	
51-162	343	13-1/2"	454	16	4/4
51-164	343	13-1/2"	567	20	4/4

Jacketed Steel Handle Hammer



51-081

- Shaft 15% longer for better balance & control in usage
- Grip 15% longer for better performance
- Individually heat-treated for long life
- Hardened and tempered tubular steel shaft for strength
- Flock-filled rubber grip for comfort and durability
- Meets ANSI standards

SKU#	HEAD LENGTH		WEIGHT		BOX/CTN
	mm	inches	grams	oz	
51-081	335	13-1/4"	450	16	6/36
51-082	335	13-1/4"	570	20	6/36

Fiberglass Nail Hammer



51-072

- Fiberglass shaft with polypropylene outer jacket
- Tape Lock union between head and shaft for safety
- Flock-filled rubber grip impervious to heat
- Meets ANSI standards
- Improved handle design for greater comfort & control

SKU#	HEAD LENGTH		WEIGHT		BOX/CTN
	mm	inches	grams	oz	
51-071	335	13-1/4"	450	16	6/36
51-072	335	13-1/4"	570	20	6/36

Jacketed Fiberglass Engineering Hammer



56-202

- Heat treated high carbon alloy steel heads for long life and durability
- Machined striking face for accuracy
- Jacketed fiberglass handle for overstrike protection

SKU#	HEAD LENGTH		WEIGHT		BOX/CTN
	mm	inches	grams	oz	
56-202	112	4-3/8"	1100	40	4/4
56-204	135	5-1/4"	1800	64	4/4

Jacketed Fiberglass Drilling Hammer



56-701

- New England pattern head is forged from high grade, hardened, tempered steel
- Machined striking face for accuracy
- Jacketed fiberglass handle for overstrike protection

SKU#	HEAD LENGTH		WEIGHT		BOX/CTN
	mm	inches	grams	oz	
56-701	106	4-1/4"	930	32	4/4
56-705	116	4-1/2"	1400	50	4/4

Jacketed Fiberglass Blacksmith Hammer



56-218

- Heat treated high carbon alloy steel heads for long life and durability
- Machined striking face for accuracy
- High visibility yellow handle is made of jacketed fiberglass for strength and durability

SKU#	HEAD LENGTH		WEIGHT		BOX/CTN
	mm	inches	grams	oz	
56-218	125	5"	1100	40	4/4
56-220	135	5-1/8"	1800	64	4/4

Wood Handle Nail Hammer



51-271

- The hammer head is attached with 2 wedges for better durability
- Natural hardwood handle
- Meets ANSI standards
- Hammer claws 15% longer for greater ease in pulling nails

SKU#	HEAD LENGTH		WEIGHT		BOX/CTN
	mm	inches	grams	oz	
51-269	330	13"	370	13	6/36
51-271	330	13"	450	16	6/36
51-274	335	13-1/4"	570	20	6/36

Ball Pein Hammer



54-190

- The hammer head is attached with 2 wedges for better durability
- Ball end used for riveting and poll used for normal striking
- Meets ANSI standards
- Handle 25% longer in 16-32oz sizes for better balance and control

SKU#	HEAD LENGTH		WEIGHT		BOX/CTN
	mm	inches	grams	oz	
54-189	311	12-1/4"	230	8	6/48
54-190	345	13"	340	12	6/48
54-191	355	14"	450	16	6/36
54-192	381	15"	680	24	6/24
54-193	405	16"	910	32	6/24

Contractor Grade™ Hickory Handle Engineering Hammer



56-804

- Forged steel head-hardened and tempered
- Faces machine finished
- Selected clear lacquered hickory handle

SKU#	HEAD LENGTH		WEIGHT		BOX/CTN
	mm	inches	grams	oz	
56-803	130	5-1/8"	1,400	50	4/4
56-804	135	5-1/4"	1,800	64	4/4

Contractor Grade™ Hickory Handle Sledge Hammer



56-812

- Forged steel head-hardened and tempered
- Faces machine finished
- Selected clear lacquered hickory handle

SKU#	HEAD LENGTH		WEIGHT		BOX/CTN
	mm	inches	grams	oz	
56-808	165	6-1/2"	3,600	127	4/4
56-812	195	7-3/4"	5,400	190	4/4
56-816	215	8-1/2"	7,300	258	2/2

Compo-Cast® Standard Head Soft Face Hammer



57-532

- Non-Sparking soft face hammers
- No exposed metal
- Soft face doesn't mar surfaces or equipment
- Steel reinforced handles provide added strength and safety, resist breaking on overstrike

SKU#	FACE DIAM.		HEAD LENGTH		O / A LENGTH		WEIGHT		BOX/CTN
	mm	inches	mm	inches	mm	inches	grams	oz.	
57-530	30	1.2"	79	3-1/8"	257	10-1/8"	284	10	1/4
57-531	40	1.6"	95	3-3/4"	286	11-1/4"	510	18	1/4
57-532	45	1.8"	103	4-1/16"	327	12-7/8"	595	21	1/4
57-533	53	2.1"	117	4-5/8"	362	14-1/4"	1,191	42	4/4
57-534	63	2.5"	136	5-3/8"	387	15-1/4"	1,474	52	1/2

Compo-Cast® Slimline Head Soft Face Hammer



57-543

- Non-Sparking soft slimline hammers
- No exposed metal
- Soft face doesn't mar surfaces
- Ideal for assembly and repair applications in confined areas
- Steel reinforced handles provide added strength and safety, resist breaking on overstrike

SKU#	FACE DIAM.		HEAD LENGTH		O / A LENGTH		WEIGHT		BOX/CTN
	mm	inches	mm	inches	mm	inches	grams	oz.	
57-540	17.5	0.7"	73	2-7/8"	238	9-3/8"	142	5	1/4
57-541	27	1.1"	106	4-3/16"	268	10-9/16"	397	14	1/4
57-542	33	1.3"	108	4-1/4"	308	12-1/8"	510	18	1/2
57-543	35	1.4"	133	5-1/4"	327	12-7/8"	595	21	1/2



57-527

Rubber Mallet

- For striking blows where steel hammers would mar or damage surface of the work

SKU#	O / A LENGTH		WEIGHT		BOX/CTN
	mm	inches	grams	oz	
57-527	350	13"	450	16	6/36
57-528	350	13"	680	24	6/24

Cushion Grip Nail Set



58-930

- Grip is slip-resistant in all weather conditions and ribbed to absorb shock, improving precision
- 25% longer length enables user to set nails in hard to reach areas
- Fully hardened, precision-milled steel for long life
- Long, beveled tip for easy nail head alignment
- Colour coded by tip size for quick identification
- Patented design developed for professional use
- 3 pc nail set (SKU# - 58-930) contains 58-911, 58-912 and 58-913

SKU#	COLOUR	O / A LENGTH		TIP		BOX/CTN
		mm	inches	mm	inches	
58-911	Yellow	127	5"	0.8	1/32"	6/96
58-912	Grey	127	5"	1.6	2/32"	6/96
58-913	Red	127	5"	2.4	3/32"	6/96
58-930	(3 Pc Set)					6/96

4/32" Tip Square Head Nail Set



58-114

- Ideal for setting nails into materials
- Long length for setting nails in hard-to-reach areas
- Fully hardened, precision-milled steel for long life
- Long, beveled tip for easy nail head alignment
- Square head prevents rolling when set down

SKU#	COLOUR	O / A LENGTH		TIP		BOX/CTN
		mm	inches	mm	inches	
58-114	Grey	101	4"	3.17	4/32	6/72

1/8" (3.2mm) Center Punch



58-120

- This Center Punch has a 1/8" (0.125"/3.2mm) tip
- 4" overall length
- 5/16" stock size
- Square head
- Hardened & tempered alloy steel centre punch
- Tips are cupped & chamfered to locate accurately onto nail head

SKU#	COLOUR	O / A LENGTH		TIP		BOX/CTN
		mm	inches	mm	inches	
58-120	Grey	100	4"	3.2	1/8"	6/72

6-Piece Wood Carving Set



16-120

- Handy carving knives in various cut ideal for DIY handicrafts
- 1 ea square chisel
- 1 ea sken chisel
- 1 ea curved gouge
- 1 ea straight gouge
- 1 ea curved flat
- 1 ea curved U tool

SKU#	CONTENTS	BOX/CTN
16-120	Square & Sken Chisel, Curved & Straight Gouge, Curved flat, Curved U tool	12/72

150 Series - 3-Piece Wood Chisel Set



16-089

- Durable precision ground cutting edges
- Blades uniformly hardened for full length use
- Blades are also heat tempered and lacquer coated to prevent rust

SKU#	DESCRIPTION	LENGTH inches	BOX/CTN
16-089	3 pcs Wood Chisel Set	1/2" x 7-3/4" 3/4" x 7-3/4" 1" x 7-3/4"	5/30

DynaGrip® Chisel

- Blade guard for storage safety
- Fully precision ground blade on all faces
- Ergonomic hi-impact resistant bi-material handle
- Rust-resistant, lacquered coated blade



16-282

SKU#	CONTENTS		BOX/CTN
	mm	inches	
16-273	6	1/4"	6/36
16-274	8	5/16"	6/36
16-275	10	3/8"	6/36
16-276	12	1/2"	6/36
16-277	14	9/16"	6/36
16-278	16	5/8"	6/36
16-279	18	3/4"	6/36
16-280	20	13/16"	6/36
16-281	22	7/8"	6/36
16-282	25	1"	6/36
16-286	30	1"	6/36
16-283	32	1-1/4"	6/36
16-287	36	1-1/2"	6/36
16-284	38	1-1/2"	6/36
16-285	12, 18, 25	1/2", 3/4", 1"	4/24

FatMax™ Concrete Chisel with Bi-Material Hand Guard

- Durable bull point that cuts fast and lasts long
- Ideal for cutting through and breaking up concrete



16-329

SKU#	CONTENT	LENGTH inches	BOX/CTN
16-329	Concrete Chisel 3/4" x 12" w/Guard	3/4" x 12"	3/18

FatMax™ Floor Chisel with Bi-Material Hand Guard

- Used for cutting, prying or ripping of hardwood flooring and nails
- Designed with offset blade and shorter bite for increased leverage



16-331

SKU#	CONTENTS	LENGTH inches	BOX/CTN
16-331	FatMax™ Floor Chisel 3" x 11" with guard	3" x 11"	3/18

FatMax™ Cold Chisel with Bi-Material Hand Guard

- For cutting/shaping wrought iron, cast iron, steel, brass, bronze, copper, aluminum, bolts, nuts and rivets



16-332

SKU#	CONTENTS	LENGTH inches	BOX/CTN
16-332	FatMax™ Cold Chisel 1" x 12" with guard	1" x 12"	3/18

FatMax™ Mason's Chisel with Bi-Material Hand Guard

- Used for cutting and splitting hard stone, brick and concrete



16-334

SKU#	CONTENTS	LENGTH inches	BOX/CTN
16-334	FatMax Mason's Chisel 2-3/4" x 8-1/2" with guard	2-3/4" x 8-1/2"	3/18

STANLEY® Cold Chisel

- One-piece construction forged from chrome vanadium steel for increased strength and durability
- Hardened, quenched and tempered for long life and added safety
- Powder coat finish for increased visibility
- For cutting/ shaping wrought iron, cast iron, steel, brass, bronze, copper, aluminum, bolts, nuts and rivets



16-286-2

SKU#	LENGTH inches	BOX/CTN
16-286-2	3/8" x 5-9/16"	3/24
16-287-2	1/2" x 6"	3/24
16-288	5/8" x 6-3/4"	3/24
16-289	3/4" x 6-7/8"	3/24
16-290	7/8" x 8"	3/24
16-291	1" x 12"	3/24

Starter Punch

- Used for starting drill holes
- One-piece construction forged from tempered tool steel for strength
- Hardened and tempered for long life
- Powder coat finish for increased visibility



16-229

SKU#	LENGTH inches	BOX/CTN
16-229	3/32" x 5-1/2"	3/24

Pin Punch

- One piece construction forged from tempered tool steel for strength
- Hardened and tempered for long life
- Powder coat finish for increased visibility



16-230

SKU#	LENGTH inches	BOX/ CTN
16-230	Pin Punch 1/16" x 6"	3/24
16-231	Pin Punch 1/8" x 6"	3/24
16-232	Pin Punch 5/32" x 6"	3/24
16-233	Pin Punch 3/16" x 6"	3/24
16-234	Pin Punch 1/4" x 6"	3/24
16-235	Pin Punch 5/16" x 6"	3/24

Prick Punch

- Used for marking metal
- One-piece construction forged from tempered tool steel for strength
- Hardened and tempered for long life
- Powder coat finish for increased visibility



16-236

SKU#	LENGTH inches	BOX/ CTN
16-236	3/8" x 5-1/2"	3/24

Center Punch

- Used for marking metal or making indentations for starting drill holes
- One piece construction forged from tempered tool steel for strength
- Hardened and tempered for long life



16-228

SKU#	CENTER PUNCH inches	BOX/ CTN
16-227	1/4" x 4"	3/24
16-228	5/16" x 4-1/2"	3/24

6-Piece Punch Kit

- Accessible packaging enables customer to easily evaluate products in store



16-226

SKU#	CONTENTS	BOX/ CTN
16-226	16-231, 16-233, 16-234, 16-235, 16-232, 16-230	3/24



55-113

Claw Bar

- Flat striking face allows claw to be driven under deeply embedded nails
- Forged, high carbon alloy steel for long life
- Tempered for safety and heat treated for durability
- Polished, beveled claws allow for precision nail pulling and prying

SKU#	OVERALL LENGTH		BOX/CTN
	mm	inches	
55-113	203	8"	6/6
55-114	254	10"	2/6
55-115	305	12"	2/6

Hexagonal Straight Bar



55-150

- A basic tool used in demolition of all type of construction, including concrete

SKU#	OVERALL LENGTH		WEIGHT		BOX/CTN
	m		lbs		
55-150	1.5		15		6/6
55-175	1.8		17		6/6

Molding Bar



55-116

- Flat surface allows users to cleanly pry molding and trim reducing material damage
- Forged high carbon alloy steel for long life
- Tempered for safety and heat treated for durability
- Polished, beveled claws allow for precision nail pulling and prying

SKU#	OVERALL LENGTH		BLADE WIDTH		BOX/CTN
	mm	inches	mm	inches	
55-116	203	8"	45	1.75"	2/6
55-117	254	10"	45	1.75"	2/6

FatMax™ Wrecking Bar



55-101

- Forged, high-carbon steel able to withstand 975 ft-lbs, of bending momentum
- Tri-lobe design increases strength, durability and ease of use
- High-visibility, powder-coated finish
- Slotted claw and beveled ends improve functionality and performance

SKU#	OVERALL LENGTH		BLADE WIDTH		BOX/CTN
	mm	inches	mm	inches	
55-101	356	14"	25	1"	4/4
55-102	610	24"	38	1.5"	4/4
55-104	914	36"	38	1.5"	4/4

Forged Hexagonal Steel Ripping Bar



55-118

- High carbon steel adds prying strength
- Chisel end is beveled
- Both slotted claw and chisel ends are polished

SKU#	LENGTH		BOX/CTN
	mm	inches	
55-118	16 x 455	5/8" x 18"	6/6
55-124	19 x 610	3/4" x 24"	6/6
55-130	19 x 760	3/4" x 30"	6/6

Wonder Bar X21 Pry Bar



55-526

- Forged high carbon steel for increased strength and durability
- 21" long for better reach and greater leverage
- Excellent for pulling nails, lifting or prying
- High-visibility, powder-coated finish

SKU#	OVERALL LENGTH		BLADE WIDTH		BOX/CTN
	mm	inches	mm	inches	
55-526	533	21"	44	1.75"	4/4

6 ILLUMINATION TOOLS

EFFICIENT, PORTABLE AND LONG LASTING

STANLEY® offers a full range of hands-free work lights and high-performance aluminum flashlights that boast the latest design innovations and LED bright-light technologies. The expanded line of LED flashlights provides convenience in a range of size and styles. The MaxLife™ 369™ Tripod and Mini Tripod models provide hands-free lighting options. Both durable and water-resistant, the flashlights offer such features as patented MaxLife™ 369™ technology, which enables the light to operate on 3, 6, or 9 batteries and to generate more than 200 hours of continuous light. These models also feature a hands-free tripod design and a multi-position head, which allows the user to aim a focused beam of light where needed. Weather-resistant and durable, this flashlight incorporates anodized aluminum space frame construction with a graphite/ABS composite head.



STANLEY® INNOVATIONS

This category includes the innovative new hands-free STANLEY® Clamp Light, which has a large spring-loaded handle that opens up to 4 inches wide for grabbing onto exposed ceiling joists, wall studs, fence posts, tabletops and/or car hoods. It features an oversized rotating, tilting head; impact-resistant housing; non-slip comfort grip; and super-bright LED bulb with shatterproof lens.

Another innovation pioneered by STANLEY® is its line of LED tripod lights. Each light can be used as a standard flashlight, but at the push of a button, 3 legs pop out, converting the handheld flashlight into a freestanding lantern. There are 4 different sizes of tripod lights, including the 3-in-1 model that can be used as a powerful handheld flashlight, as a freestanding lantern, or disassembled and used as 3 separate smaller flashlights.

WHY STANLEY® ILLUMINATION TOOLS

1 Competitive Advantage

10 extensive tests to ensure the best quality on the market

- Patented hands free tripod design
- Patented 3, 6, 9 technology – ability to use 3, 6, or 9 batteries without sacrificing brightness
- Patented 3 flashlights in 1 technology

2 Market Trends

- L.E.D. flashlights = more energy efficient, brighter light, longer life
- Inconsistent lumen claims = ANSI standards



95-155



3-in-1 Tripod LED Flashlight

- Patented hands free tripod design
- Separates into 3 independent flashlights
- Combines into one powerful flashlight
- Each independent flashlight generates 20 lumens of light
- Three 120 degree multi-directional rotating heads
- Shatter resistant lens
- ON/OFF switch turns all flashlights on or off when placed inside the tripod base
- One-touch tripod release button
- Uses 6 AA batteries

SKU#	BATTERIES		BRIGHTNESS	BULB TYPE	BEAM DISTANCE		IMPACT RESISTANCE		HEIGHT		BOX/CTN
	(NOT INCLUDED)	RUN TIME			ft	m	ft	m	in	mm	
95-155	6 AA (2 per Flashlight)	5 Hrs	100 Lumens (34 Lumens @)	1/2W LED	375	115	3	0.9	13-3/4"	349	4/4

MAXLIFE™ 369™ Tripod Flashlight



95-112W

- Tripod design provides capability for hands-free use
- Magnetized and anodized aluminum tripod legs fold together to become a regular hand-held flashlight
- 3-6-9 technology gives user the choice to run the flashlight on 3, 6 or 9 AA batteries
- 100° rotational head with shatter-resistant lens focuses light where it's needed most
- One 1/2-watt bright white, long-lasting LED delivers a strong spot beam
- Slip-resistant rubber grip and feet
- On/Off switch
- Compliant with ANSI, CE and RoHs standards

SKU#	BATTERIES		BRIGHTNESS	BULB TYPE	BEAM DISTANCE		IMPACT RESISTANCE		HEIGHT		BOX/CTN
	(NOT INCLUDED)	RUN TIME			ft	m	ft	m	in	mm	
95-112W	3,6 or 9 AA	90 hrs (using 9 AA)	20 Lumens	1/2 W LED	282	86	3	0.9	11-8/9"	302	6/6



95-111

MAXLIFE™ Mini LED Tripod Flashlight

- Innovative, compact tripod design offers hands-free convenience
- Weather-resistant anodized aluminum space frame construction tripod legs fold to become a regular hand-held flashlight.
- Perfect for a project or emergency situation
- Multi-position head focuses light precisely where it's needed
- Low-power indicator light flashes so you're never caught in the dark
- Durable, impact-resistant design with a graphite ABS composite head and shatter-resistant polycarbonate lens
- Simple 4-position switch lets you choose Low, Medium, High or Off
- Runs on 3 AAA batteries (not included) - must run on minimum of 3 batteries

SKU#	BATTERIES		BRIGHTNESS	BULB TYPE	IMPACT RESISTANCE		HEIGHT		BOX/CTN
	(NOT INCLUDED)	RUN TIME			ft	m	in	mm	
95-111	3AAA	10 hrs	8 Lumen	5mm LED	3	0.9	7-1/2"	2.3	4/24

MAXLIFE™ 369™ Tripod Flashlight - Titanium Finish



95-115

- Bright-white 1.25 Watt LED light
- Spot-to-flood light focusing capability
- Innovative tripod design offers hands-free convenience
- Weather-resistant anodized aluminum space frame construction tripod legs
- Perfect for a project or emergency situation
- Multi-position head focuses light precisely where it's needed
- Low-power indicator light flashes so you're never caught in the dark
- Durable, impact-resistant design with a graphite ABS composite head and shatter-resistant polycarbonate lens
- Simple 3-position switch lets you choose Low, High or Off
- Runs on 3, 6, or 9 AA batteries (not included) depending on usage requirement

SKU#	DESCRIPTION	BOX/CTN
95-115	MaxLife™ 369 Tripod Flashlight - Titanium Finish	1/4

Mini Tripod LED Flashlight with keychain-Black/Sliver Finish



95-113X

- Patented tripod design offers hands-free convenience
- Multi-position head focuses light precisely where it's needed
- On/Off Switch
- Swivel key ring for convenience
- Bulbs: One 5mm LEDs last 100,000 hrs
- Brightness: 2 Lumens
- Run time: 6 hours
- Includes 3 replaceable lithium button cell batteries (LR41)

SKU#	BATTERIES		BRIGHTNESS	BULB TYPE	IMPACT RESISTANCE		HEIGHT		BOX/CTN
	INCLUDED	RUN TIME			ft	m	in	mm	
95-113X	3LR41	6 hrs	2 Lumens	5mm LED	3	0.9	3-3/8"	86	10/60

1 MEASURING & LAYOUT TOOLS
2 LASER MEASURING SYSTEM
3 CUTTING & HOLDING TOOLS
4 FASTENING TOOLS
5 STRIKING & STOCK TOOLS
6 ILLUMINATION TOOLS
7 PAINTING & FINISHING TOOLS
8 MECHANICAL TOOLS
9 TOOLS STORAGE
10 POWER TOOLS
11 POWER TOOLS ACCESSORIES
12 POWER TOOLS ACCESSORIES
13 PRODUCT INDEX

7 PAINTING AND FINISHING TOOLS

SMOOTH, FAST AND ACCURATE

STANLEY® is proud of its long-standing commitment to manufacturing some of the world's best finishing tools. Owning quality finishing tools says a lot about how serious a woodworker you are. STANLEY®'s line of finishing tools is made with quality materials. The parts are precision ground. And they have features that give woodworkers greater control and accuracy. STANLEY®'s celebrated line of Surform® tools, which comprises five different super-versatile implements designed for quickly smoothing, shaping and contouring a wide variety of materials ranging from wood, drywall and rabbit to copper, aluminum and brass. A wide variety of Surform® replacement blades is available too.



WHAT IS SURFORM®?

The word SURFORM® is derived from the two words : SURface FORMing

- **ALL-IN-ONE:** Two-handed planes, files, one-handed planes and shaver
- **REPLACEABLE BLADES:** Blade provides the advantages over other tool alternatives, such as files; rasps and planes
 1. Rows of "D" shaped holes are punched through the blade
 2. Producing sharp chisel-like teeth
 3. After hardening, the teeth will cut through materials in the same way that a grater cuts cheese
 4. Shavings pass through the blade and do not clog



IDEAL FOR ANY SURFACE REMOVAL

- Remove paint
- Drywall edging
- Automotive body filler
- Filing
- Planing
- Shaving

SURFORM® TOOLS

SURFORM® Shaver



- Two handed use
- Light material removal
- Side cut teeth in blade useful for shaving in corners
- Works on the pull stroke

Pocket Plane



- One handed use
- Light wood removal
- ideal for end grain work, sheet rocking & smoothing edges of laminates

SURFORM® Flat File



- Two handed use
- Moderate to heavy wood removal
- Superb tool for use as a rasp on wood, plastic and soft metals

SURFORM® Plane



- Two handed use
- Moderate wood removal
- For materials that would dull a traditional bench plane blades

HOW TO USE SURFORM® TOOLS

For FAST CUTTING use the tool at an angle of about 30° to the direction of cut



For SMOOTHING and FINISHING, use the tool parallel to the direction of cut



Standard Cut



- Light material removal
- All-Purpose blade
- Serrated edge for edge cutting

Fine Cut

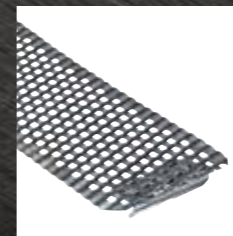

- Light wood removal
- Ideal for finishing work, end grain, wallboards and soft metals

Round File

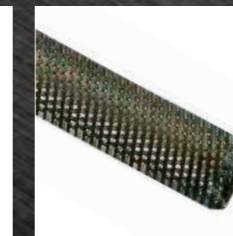

- Moderate wood removal
- Used for enlarging or changing the shape of holes or small concave edges

Shaver



- Light material removal
- Side cut teeth in blade useful for shaving in corners

Half Round



- Moderate wood removal
- Half Round convex blade used for fast stock removal and shaping curved surfaces

Paint Roller - Complete

SKU#	CONTENTS	FOR USE ON	LENGTH		DIAMETER		BOX/CTN
			mm	inches	mm	inches	
29-064-1	7" Cage roller/ mogloss short refill	Gloss and eggshell paints on smooth surfaces	175	7"	37	1-1/2"	24/48
29-494-1	7" Cage roller/ acrylic med refill	Flat of masonry paint on semi smooth/rough surfaces	175	7"	37	1-1/2"	24/48
29-493-1	7" Cage roller/ acrylic long refill	Flat of masonry paint on semi smooth/rough surfaces	175	7"	37	1-1/2"	24/48
29-069-1	9" Cage roller/ mogloss short refill	Gloss and eggshell paints on smooth surfaces	255	9"	37	1-1/2"	24/48
29-401-1	9" Cage roller/ acrylic med refill	Flat/matt paint smooth/ semi smooth surfaces	255	9"	37	1-1/2"	24/48
29-400-1	9" Cage roller/ acrylic long refill	Flat/matt paint smooth/ semi smooth surfaces	255	9"	37	1-1/2"	24/48

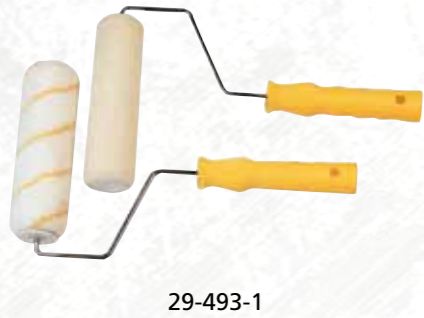

Mini Roller & Refill

SKU#	CONTENTS	FOR USE ON	LENGTH		BOX/CTN
			mm	inches	
29-814-1	Mini Roller Frame + Refill (29-086-0 + 29-816)	Water based gloss and eggshell	100	4"	24/48
29-078-2	Acrylic Yellow Stripe Refill - 2/pk	Flat/ matt paint on smooth surfaces	100	4"	10/100
29-078-5	Acrylic Yellow Stripe Refill - 10/pk	Flat/ matt paint on smooth surfaces	100	4"	10/20
29-816-2	High Density Foam Refill - 2/pk	Water based gloss and eggshell paints on smooth surfaces	100	4"	20/100
29-816-5	High Density Foam Refill - 10/pk	Water based gloss and eggshell paints on smooth surfaces	100	4"	10/20
29-808-5	Velour Roller Refills	Velour Fabric for gloss paints on smooth surfaces	100	4"	10/20
29-480-1	Mini Roller Kit : 1 roller head for flat/ matt paint and 1 for gloss and varnish	Dual purpose- for emulsion and gloss	100	4"	24/48



Stick & Cage Frame Roller

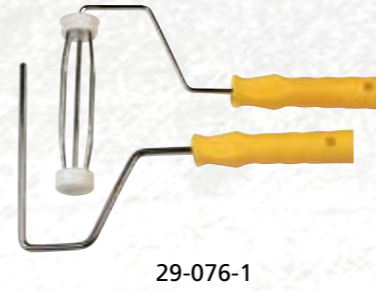

SKU#	CONTENTS	LENGTH		DIAMETER		BOX/CTN
		mm	inches	mm	inches	
29-076-1	7" Stick Roller Frame	-	7"	-	-	24/48
29-772-1	9" Stick Roller Frame	-	9"	-	-	24/48
29-044-1	7" Cage Frame	175	7"	37	1-1/2"	24/48
29-045-1	9" Cage Frame	255	9"	37	1-1/2"	24/48

Stick Roller Refill



SKU#	CONTENTS	FOR USE ON	LENGTH		BOX/CTN
			mm	inches	
29-278-0	9" Green Acrylic Long Pile	Flat/ matt paint on smooth surfaces	225	9"	24/48
29-277-0	9" Acrylic Yellow Stripe Med Pile	Flat/ matt paint on smooth surfaces	225	9"	24/48
29-256-0	7" Mogloss Short Pile	Gloss and eggshell paints on smooth surfaces	175	7"	24/48
29-276-0	9" Mogloss Short Pile	Gloss and eggshell paints on smooth surfaces	225	9"	24/48
29-082-1	4" Stick Frame and 1 velour refill	-	102	4"	24/48
29-086-0	4" Stick Frame and refill	-	102	4"	25/100

Cage Frame Roller Refill



SKU#	CONTENTS	FOR USE ON	LENGTH		BOX/CTN
			mm	inches	
29-999-0	9" Green Acrylic Long Pile	Flat/ matt paint on smooth surfaces for 29-045-1 Cage Roller Frame	225	9"	36/144
29-259-0	7" Acrylic Yellow Stripe Med Pile	Flat/ matt paint on smooth surfaces for 29-044-1 Cage Roller Frame	175	7"	36/144
29-279-0	9" Acrylic Yellow Stripe Med Pile	Flat/ matt paint on smooth surfaces for 29-045-1 Cage Roller Frame	225	9"	36/144
29-861-0	7" Mogloss Short Pile	Gloss and eggshell paints on smooth surfaces for 1-29-044 Cage Roller Frame	175	7"	36/144
29-862-0	9" Mogloss Short Pile	Gloss and eggshell paints on smooth surfaces for 29-045-1 Cage Roller Frame	225	9"	36/144

Cage Frame Roller & Tray Set



29-821-1

SKU#	CONTENTS	FOR USE ON	LENGTH		LENGTH		BOX/CTN
			mm	inches	mm	inches	
29-821-1	7" Rollers & Tray Set (29-044-1 + 29-259-0)	For flat/matt paint on smooth or semi smooth surfaces	175	7"	37	1-1/2"	12/24
29-822-1	9" Rollers & Tray Set (29-045-1 + 29-279-0)	For flat/matt paint smooth or semi smooth surfaces	225	9"	37	1-1/2"	12/12

Extension Pole



29-671-1

- 2.3m length, extends over 7ft
- Sturdy metal construction
- Easy twist
- Ideal for use with paint rollers and paint pads

SKU#	OVERALL LENGTH	BOX/CTN (DOZEN)
29-671-1	1.3 - 2.3m	1/24

AllMaster Paint Brush



29-033-1

29-035-1

- Long bristle for durability and superior finish
- Wooden handle for comfort in use
- Stainless steel ferrules
- Superior finish with all paints

SKU#	SIZE		THICKNESS		LENGTH-OUT		BOX/CTN (DOZEN)
	mm	inches	mm	inches	mm	inches	
29-030-1	19	3/4"	9	11/32"	49	2"	12/288
29-031-1	25	1"	15	13/16"	58	2-1/4"	12/288
29-032-1	38	1-1/2"	18	5/8"	58	2-1/4"	12/288
29-033-1	50	2"	19	2/3"	67	2-5/8"	12/144
29-034-1	63	2-1/2"	20	2/3"	72	2-7/8"	12/144
29-035-1	75	3"	23	3/4"	79	3-1/8"	6/72
29-036-1	100	4"	23	3/4"	83	3-1/4"	6/72

Planer File



21-122-5

- Can be used as either a plane or a file
- Fitted with replaceable standard cut blade and supplied with one spare blade

SKU#	DESCRIPTION	SIZE		PACKAGING	BOX/CTN
		mm	inches		
21-122-5	10" Surform Planer File	250	10"	Clamshell	2/12

Shaver Tool



21-115-5

- Lightweight, molded body
- Work on pull stroke
- For universal use

SKU#	DESCRIPTION	SIZE		PACKAGING	BOX/CTN
		mm	inches		
21-115-5	2-1/2" Surform® Shaver Tool	64	2-1/2"	Clamshell	6/6

Block Plane



21-399-5

- One handed tool specially suited for smoothing edges and small surfaces areas

SKU#	DESCRIPTION	SIZE		PACKAGING	BOX/CTN
		mm	inches		
21-399-5	5-1/2" Surform® Block Plane	140	5-1/2"	Clamshell	2/24

Plane



21-103-5

- Lightweight, molded body
- General purpose use

SKU#	DESCRIPTION	SIZE		PACKAGING	BOX/CTN
		mm	inches		
21-103-5	10" Surform® Plane	250	10"	Clamshell	6/6

Block Plane



21-104-5

- Lightweight, moulded body
- For edges and confined spaces

SKU#	DESCRIPTION	SIZE		PACKAGING	BOX/CTN
		mm	inches		
21-104-5	5-1/2" Surform® Block Plane	140	5-1/2"	Clamshell	6/6

Flat File



21-102-5

- Lightweight, molded body
- Slight curve on blade for increased stock removal

SKU#	DESCRIPTION	SIZE		PACKAGING	BOX/CTN
		mm	inches		
21-102-5	5-1/2" Surform Flat File	140	5-1/2"	Clamshell	6/6

Standard Cut Blade



21-293-5

- All purpose blade
- Use on wood, vinyl, plaster thermalite, fiberglass and linoleum
- Standard cut blade features teeth flush to the blade edge for working into edges

SKU#	DESCRIPTION	LENGTH		WIDTH		FOR USE ON	BOX/CTN
		mm	inches	mm	inches		
21-293-5	Surform® Standard Cut Blade	250	10"	42	1-5/8"	21-103, 21-122, 21-195, 21-296	12/12

Fine Cut Blade

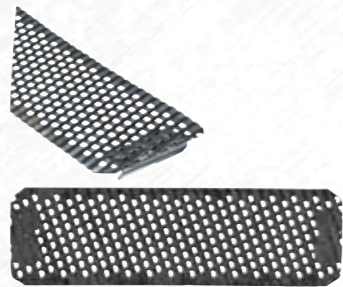

21-398-5

SKU#	DESCRIPTION	LENGTH		WIDTH		FOR USE ON	BOX/CTN
		mm	inches	mm	inches		
21-398-5	Surform® Fine Cut Blade	140	5-1/2"	42	1-5/8"	21-102, 21-104, 21-399	12/12

Metal & Plastic Blade

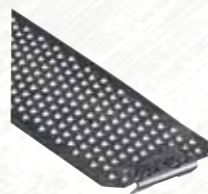

21-508-5

- Use on soft metals (e.g. brass, lead, aluminum, copper and mild steel), plastic, laminates, plastic fillers and fiberglass

SKU#	DESCRIPTION	LENGTH		WIDTH		FOR USE ON	BOX/CTN
		mm	inches	mm	inches		
21-508-5	Surform® Metal & Plastic	250	10"	42	1-5/8"	21-103, 21-122, 21-295, 21-296	12/12

10" Surform® Round Replacement Blade



21-291-5

- Length - 10"/254mm
- Width - 5/8", 15.88mm
- Cut Type - Regular
- Used for enlarging holes and smoothing curved surfaces
- Can be used as a replacement blade on 21-297 Surform® Round File

SKU#	DESCRIPTION	LENGTH		WIDTH		FOR USE ON	BOX/CTN
		mm	inches	mm	inches		
21-291-5	Surform Round Replacement Blade	254	10"	15.8	5/8"	21-297	6/6

Surform® Flat File – Regular Cut Blade



21-295-5

- Length – 17-3/8", 441.33mm
- Width – 1-5/8", 41.28mm
- Cut Type – Regular
- Superb tool for use as a rasp on wood, plastic, soft metals and many other materials
- Manufactured with a metallic-gray, die-cast alloy body
- High-impact polymer handle holds up to heavy use
- Fitted with a replaceable (10"/250mm) blade
- Use replacement blade 21-293 for standard cut, 21-393 for fine cut and 21-299 for half round

SKU#	DESCRIPTION	LENGTH		WIDTH		FOR USE ON	BOX/CTN
		mm	inches	mm	inches		
21-295-5	Surform Flat File - Regular Cut Blade	441.33	17-3/8"	41.28	1-5/8"	Wood, Plastic, Soft Metals, etc.	2/2

10" Surform® Half Round Regular Cut Replacement Blade



21-299-5

- Length – 10", 254mm
- Width – 1-1/2", 38.1mm
- Cut Type - Regular
- Half-round convex blade used for fast stock removal and shaping curved surfaces
- Ideal for work on fiberglass and removing filler (for cars and boats)
- Can be used as a replacement blade on 21-295 Surform® Flat File - Regular Cut Blade and 21-296 Surform® Plane Type - Regular Cut Blade

SKU#	DESCRIPTION	LENGTH		WIDTH		FOR USE ON	BOX/CTN
		mm	inches	mm	inches		
21-299-5	Regular Cut Replacement Blade	254	10"	38.1	1-1/2"	21-295, 21-296	12/12

10" Surform® Standard Cut Flat Replacement Blade

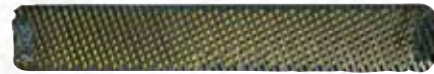

21-393-5

- Length - 10"/254mm
- Width - 1-5/8", 41.28mm
- Cut Type - Fine
- Produces a fine finish on hardwoods, end grains and soft metals
- Can be used as a replacement blade on 21-295 Surform® Flat File - Regular Cut Blade and 21-296 Surform® Plane Type - Regular Cut Blade

SKU#	DESCRIPTION	LENGTH		WIDTH		FOR USE ON	BOX/CTN
		mm	inches	mm	inches		
21-393-5	Standard Cut Flat Replacement Blade	254	10"	41.28	1-5/8"	21-295, 21-296	12/12

2-1/2" Surform® Shaver Replacement Blade

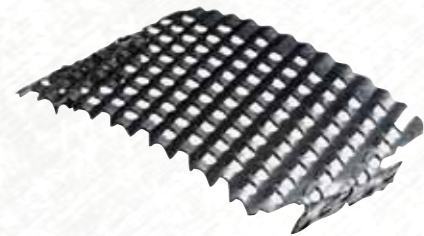

21-515-5

- Length - 2-1/2"/63.5mm
- Width - 1-5/8", 41.28mm
- Cut Type - Regular
- Curved blade speeds up stock removal
- Works on the pull stroke
- Can be used as a replacement blade on 21-115, 7-1/4" Surform® Shaver

SKU#	DESCRIPTION	LENGTH		WIDTH		FOR USE ON	BOX/CTN
		mm	inches	mm	inches		
21-515-5	Surform Shaver Replacement Blade	63.5	2-1/2"	41.28	1-5/8"	21-115	12/12

Grout Knife



94-826

- TPR handle
- With extra cutting knife
- With STANLEY® logo engraved on the body

SKU#	DESCRIPTION	BOX/CTN
94-826	Carbide Tile Grout/1 pcs extra cutting knife	6/36

Grout Blade



94-825

- With STANLEY® logo engraved on the body
- Three pieces per set

SKU#	DESCRIPTION	BOX/CTN
94-825	3 pcs/set/ Tile Grout Blades	12/120

3" Putty Knife



28-205

- Ergonomic bi-material handle
- Flexible metal tip for even coverage
- Hardened, tempered and polished steel blade
- Permanently fastened full tang blade
- Blade Width 3"

SKU#	DESCRIPTION	BOX/CTN
28-205	Putty knife, flexible tip 3"	6/24
28-208	Putty knife, flexible tip 4"	4/16

Retractable Razor Blade Scraper



28-500

- Removes paint, glue, putty or adhesive from glass, tile, walls, floors or other smooth surfaces
- Blade retracts for safe storage
- Uses standard single edge razor blades
- Comes with 5 blades

SKU#	DESCRIPTION	OVERALL LENGTH		CHUCK SIZE		BOX/CTN
		mm	inches	mm	inches	
28-500	Retractable Razor Blade Scraper	95	3-3/4"	-	-	10/100

10-Pack Single Edge Razor Blades



28-510

- Steel-backed high carbon steel blade fits most standard razor blade tools
- Replacement blades for STANLEY® 28-100 and 28-500 scrapers

SKU#	DESCRIPTION	OVERALL LENGTH			BOX/CTN
		mm	inches	Thickness	
28-510	Scraper-bl'd for 28-500	38	1-1/2"	0.009"	10/100

Single-Edge Razor Blade



11-515

- Steel backed high carbon steel blade fits all standard razor blade tools
- Replacement blades for 28-100 and 28-500 scrapers

SKU#	DESCRIPTION	OVERALL LENGTH			BOX/CTN
		mm	inches	Thickness	
11-515	Single Edge Razor Blade - 100pcs/Box	38	1-1/2"	0.009"	1/50



12-004-1

Bailey® Professional Smoothing Plane

- General purpose planes for workshop, site or fine finishing or high quality work

SKU#	LENGTH		CUTTER		BOX/CTN
	mm	inches	mm	inches	
12-003-1	240	9-1/2"	45	1-3/4"	1/6
12-004-1	245	9-3/4"	50	2"	1/6



12-006-1

Bailey® Professional Fore Plane

- For stock removal and truing up long edges or leveling wide boards

SKU#	LENGTH		CUTTER		BOX/CTN
	mm	inches	mm	inches	
12-006-1	460	18"	60	2- 3/8"	1/1



12-005-1

Bailey® Professional Jack Plane

- For rapid stock removal prior to commencing construction work
- A good general purpose plane

SKU#	LENGTH		CUTTER		BOX/CTN
	mm	inches	mm	inches	
12-005-1	355	14"	50	2"	1/6



12-007-1

Bailey® Professional Jointer Plane

- For accurate truing of long edges

SKU#	LENGTH		CUTTER		BOX/CTN
	mm	inches	mm	inches	
12-007-1	560	22"	60	2-3/8"	1/1



12-220-1

Professional™ Block Plane

- Adjustable for depth of cut and alignment
- General purpose

SKU#	LENGTH		CUTTER		BOX/CTN
	mm	inches	mm	inches	
12-220-1	180	7"	40	1-5/8"	1/6



12-060-1

Professional™ Block Plane

- Low angle cutter seats at 13-1/2"
- For end grain and plastic laminates

SKU#	LENGTH		CUTTER		BOX/CTN
	mm	inches	mm	inches	
12-060-1	150	6"	35	1-3/8"	1/6



12-116-1

Block Plane

- General purpose block plane
- Ideal for model makers

SKU#	LENGTH		CUTTER		BOX/CTN
	mm	inches	mm	inches	
12-116-1	180	7"	40	1-5/8"	1/6



12-102-1

Block Plane

- Small block plane - ideal for use by model makers

SKU#	LENGTH		CUTTER		BOX/CTN
	mm	inches	mm	inches	
12-102-1	140	5-1/2"	35	1-3/8"	1/6



12-078-1

Professional Duplex Rabbet Plane

- Two cutter positions for regular and bull nose work
- Cutter adjustable for depth of cut in the rear position
- Supplied with an adjustable fence, depth gauge and cutting spur

SKU#	LENGTH		CUTTER		BOX/CTN
	mm	inches	mm	inches	
12-078-1	254	10"	38	1-1/2"	1/1

Professional™ Smoothing Plane



12-020-1

- Fully adjustable for depth of cut, cutter alignment and size of mouth
- Cutter seats at 21°
- For end grain and general purpose fine finishing

SKU#	LENGTH		CUTTER		BOX/CTN
	mm	inches	mm	inches	
12-020-1	160	6-1/4"	40	1-5/8"	1/6

Smoothing Plane



12-203-1

- Fine grey iron castings machined and ground for precision
- Fully hardened carbon chrome steel cutter is adjustable for depth of cut and alignment

SKU#	LENGTH		CUTTER		BOX/CTN
	mm	inches	mm	inches	
12-203-1	240	9-1/2"	45	1-3/4"	1/6
12-204-1	245	9-3/4"	50	2"	1/6
12-205-1	355	14"	50	2"	1/6

Bench Plane



12-034-1

- Light-duty, easy and simple to adjust smoothing planes

SKU#	LENGTH		CUTTER		BOX/CTN
	mm	inches	mm	inches	
12-033-1	222	8-3/4"	45	1-3/4"	1/6
12-034-1	247	9-3/4"	50	2"	1/6

Spokeshaves Blade



12-350-1

- Heat-treated carbon steel

SKU#	COMPATIBLE TO -	WIDTH		BOX/CTN
		mm	inches	
12-350-1	12-151, 12-152	55	2-1/8"	6/6
12-336-1	12-064, 12-062	45	1-3/4"	6/6

Replacement Plane Iron

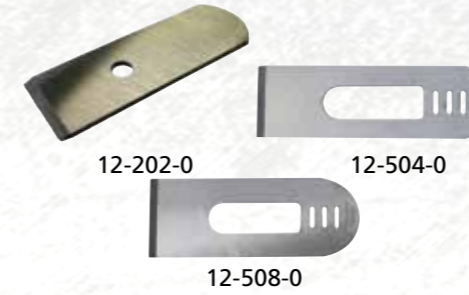

12-202-0 12-504-0 12-508-0

SKU#	COMPATIBLE TO -	WIDTH		BOX/CTN
		mm	inches	
12-202-0	12-102	34	1-5/16"	6/6
12-504-0	12-060	35	1-3/8"	6/6
12-508-0	12-020 & 12-220	40	1-5/8"	6/6
12-330-0	12-116	40	1-5/8"	6/6

Replacement Plane Iron



12-134-0

- Use suffix '0' for carded product

SKU#	COMPATIBLE TO -	WIDTH		BOX/CTN
		mm	inches	
12-134-0	2" for 12-034-1	50	2"	6/6

Single Iron



12-312-1

- A flat surface that is easier to sharpen
- An accurately ground edge of 25°
- Use suffix '0' for carded product
- Chrome carbon steel which has excellent edge retention characteristics and allows a razor sharp edge to be honed

SKU#	DESCRIPTION	COMPATIBLE TO -	WIDTH		BOX/CTN
			mm	inches	
12-312-0	Iron-single 25mm 1"	12-003	25	1"	6/6
12-312-1	Iron-single 45mm 1-3/4"	12-003	45	1-3/4"	6/96
12-313-0	Iron-single 50mm 2"(carded)	12-004, 12-005	50	2"	6/6
12-313-1	Iron-single 50mm 2"	12-004, 12-005	50	2"	6/96

Step #1 - Match file type to material shape



Step #2 - Select File coarseness

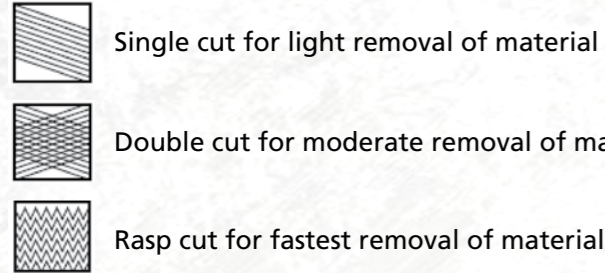

Step #3 - Select Spacing of File Teeth

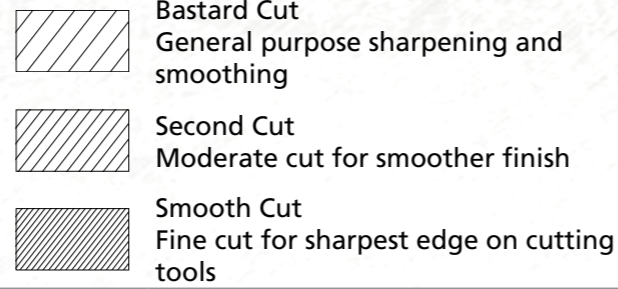

Tapered File

- For sharpening handsaws

INDIVIDUALLY CARDED

SKU#	DESCRIPTION	LENGTH		BOX/CTN (DOZEN)
		mm	inches	
22-090	Extra Slim Tapered - Second Cut	100	4"	1/12
22-091	Double Extra Slim Tapered - Second Cut	100	4"	1/12
22-092	Slim Tapered - Second Cut	175	7"	1/9
22-093	Slim Tapered - Second Cut	200	8"	1/9
22-094	Slim Tapered - Second Cut	250	10"	1/6
22-214	Three Square Tapered - Bastard Cut	250	10"	1/6
22-222	Three Square Tapered - Bastard Cut	150	6"	1/12
22-223	Three Square Tapered - Bastard Cut	200	8"	1/9
22-224	Three Square Tapered - Bastard Cut	300	12"	1/4
22-225	Three Square Tapered - Second Cut	300	12"	1/4
22-226	Three Square Tapered - Smooth Cut	150	6"	1/12
22-227	Three Square Tapered - Smooth Cut	200	8"	1/9
22-228	Three Square Tapered - Smooth Cut	250	10"	1/6
22-229	Three Square Tapered - Smooth Cut	300	12"	1/4
22-304	Slim Tapered - Second Cut	100	4"	1/12
22-305	Slim Tapered - Second Cut	125	5"	1/12
22-306	Slim Tapered - Second Cut	150	6"	1/12



22-090

Round File

- For circular openings and concave surfaces

INDIVIDUALLY CARDED

SKU#	DESCRIPTION	LENGTH		BOX/CTN (DOZEN)
		mm	inches	
22-098	Rounded - Bastard Cut	200	8"	1/9
22-178	Rounded - Bastard Cut	250	10"	1/6
22-179	Rounded - Second Cut	300	12"	1/4
22-180	Rounded - Second Cut	150	6"	1/12
22-181	Rounded - Second Cut	200	8"	1/9
22-182	Rounded - Second Cut	250	10"	1/6
22-183	Rounded - Smooth Cut	300	12"	1/4
22-193	Rounded - Smooth Cut	300	12"	1/4
22-235	Rounded - Smooth Cut	150	6"	1/12
22-236	Rounded - Smooth Cut	200	8"	1/9
22-237	Rounded - Smooth Cut	250	10"	1/6
22-238	Rounded - Smooth Cut	100	4"	1/12
22-307	Rounded - Bastard Cut	150	6"	1/12



22-098

Half Round File

- For flat, concave and convex surfaces

INDIVIDUALLY CARDED W/HANDLE

SKU#	DESCRIPTION	LENGTH		BOX/CTN (DOZEN)
		mm	inches	
22-099	Half-round Bastard	250	10"	1/6
22-184	Half-round Bastard	150	6"	1/12
22-185	Half-round Bastard	300	12"	1/4
22-186	Half-round 2nd Cut	150	6"	1/12
22-187	Half-round 2nd Cut	200	8"	1/9
22-188	Half-round 2nd Cut	250	10"	1/6
22-189	Half-round 2nd Cut	300	12"	1/4
22-192	Half-round Smooth	300	12"	1/4
22-209	Half-round Smooth	100	4"	1/12
22-210	Half-round Smooth	150	6"	1/12
22-211	Half-round Smooth	200	8"	1/9
22-212	Half-round Smooth	250	10"	1/6
22-308	Half-round Bastard	200	8"	1/9



22-099

Flat File

- For general work on iron & steel

INDIVIDUALLY CARDED

SKU#	DESCRIPTION	LENGTH		BOX/CTN (DOZEN)
		mm	inches	
22-095	Mill Bastard	150	6"	1/12
22-096	Mill bastard	250	10"	1/8
22-097	Mill bastard	300	12"	1/4
22-169	Flat Bastard	100	4"	1/12
22-170	Flat Bastard	150	6"	1/12
22-171	Flat Bastard	200	8"	1/9
22-172	Flat Bastard	250	10"	1/6
22-173	Flat Bastard	300	12"	1/4
22-174	Flat 2nd Cut	150	6"	1/12
22-175	Flat 2nd Cut	200	8"	1/9
22-176	Flat 2nd Cut	250	10"	1/6
22-177	Flat 2nd Cut	300	12"	1/4
22-190	Flat Smooth	150	6"	1/12
22-191	Flat Smooth	300	12"	1/4
22-198	Flat Smooth	100	4"	1/12
22-233	Flat Smooth	200	8"	1/9
22-234	Flat Smooth	250	10"	1/6
22-309	Mill Bastard	200	8"	1/9



22-172

Handy File

- For sharpening agricultural tools including blades of reaping and mowing machines

INDIVIDUALLY CARDED

SKU#	DESCRIPTION	LENGTH		BOX/CTN (DOZEN)
		mm	inches	
22-078H	File Handy 8" C/W Handle	200	8"	1/6
22-078HC	Handy File - Bastard Cut	200	8"	1/6
22-080B	File-Handy 10" (12pcs/box)	250	10"	1/6



22-078HC

Chain Saw File

- For sharpening chain saws

INDIVIDUALLY CARDED

SKU#	DESCRIPTION	LENGTH		BOX/CTN (DOZEN)
		mm	inches	
22-082	Chain Saw File	4 x 200	5/32" x 8"	1/9
22-083	Chain Saw File	5 x 500	3/16" x 8"	1/9
22-087	Chain Saw File	6 x 200	7/32" x 8"	1/9
22-089	Chain Saw File	6.25 x 200	1/4" x 8"	1/9



22-083

Square File

INDIVIDUALLY CARDED

SKU#	DESCRIPTION	LENGTH		BOX/CTN (DOZEN)
		mm	inches	
22-194	Square - Bastard Cut	150	6"	1/12
22-195	Square - Bastard Cut	250	10"	1/6
22-196	Square - Second Cut	250	10"	1/6
22-197	Square - Smooth Cut	250	10"	1/6
22-213	Square - Bastard Cut	200	8"	1/9
22-215	Square - Bastard Cut	300	12"	1/4
22-216	Square - Second Cut	300	12"	1/4
22-217	Square - Smooth Cut	150	6"	1/12
22-218	Square - Smooth Cut	200	8"	1/9
22-219	Square - Smooth Cut	300	12"	1/4



Knife File

INDIVIDUALLY CARDED

SKU#	DESCRIPTION	LENGTH		BOX/CTN (DOZEN)
		mm	inches	
22-241	Knife - Bastard Cut	150	6"	1/12
22-242	Knife - Bastard Cut	200	8"	1/9
22-243	Knife - Bastard Cut	250	10"	1/6
22-246	Knife - Smooth Cut	150	6"	1/12
22-247	Knife - Smooth Cut	200	8"	1/9
22-248	Knife - Smooth Cut	250	10"	1/6

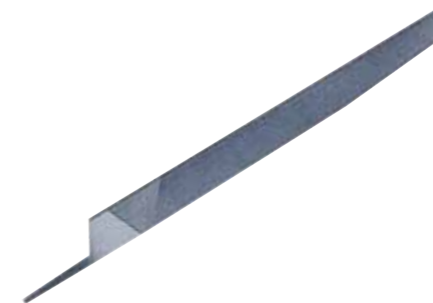

8 MECHANIC TOOLS

STRONG, ECONOMICAL AND EFFECTIVE

The STANLEY® offering of Mechanic tools supplies professionals with a wide range of product options to successfully accomplish the job at hand.



MAKE YOUR SOCKET SETS WORK HARDER

NUTS SHOULD TURN SMOOTHLY

To effectively use sockets you need to be sensitive to the way in which the nut turns on the bolt or screw stud. If the nut does not rotate smoothly check to see that the thread is not 'crossed' or if the thread size or type differs from the bolt.

TAKE CARE NOT TO OVER TIGHTEN

Run the nut up until finger tight and then apply the socket to finally tighten the nut. Under normal conditions do not be tempted to over tighten fastenings.

USE A TORQUE WRENCH FOR EXACT SPECIFICATIONS

If the torque required to complete the fastening needs to be specific for functional or safety reasons you should use a torque wrench.

USE THE RIGHT SIZE SOCKET

Even though the socket may locate on a nut that is slightly smaller the result may well be that the corners of the fastener will be deformed and make future removal difficult. The size of the ratchet handle is also carefully matched to a given set of socket sizes so that damage to the fastening is minimised. Whenever possible pull the ratchet handle towards you for better control.

LOCKING EXTENSION BAR

If you need to work on a fastener beyond your normal reach a locking extension bar will enable you to reach the nut without the risk of leaving the socket embedded in the machinery or engine compartment.

SOCKETS

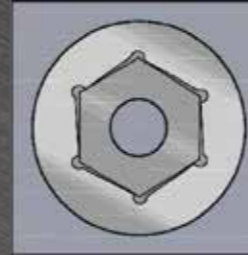

Sockets are available in either hex (6 points) or bi-hex (12 points). The bi-hex socket provides greater access when the nut is in a hard to reach position. The hex socket, although with reduced angular accessibility, tends to be able to withstand heavier duty use.

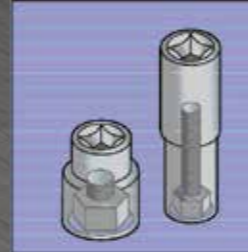

Maxi Drive profile sockets are the most efficient and offer protection to both the fastener and the socket wall by taking the driving force away from the extreme corners of the nut where there is the greatest risk of damage.

Sockets are available in standard length, for most general-purpose applications and deep drive, which come into their own if you need to tighten a nut on longer screw studs.

THE RIGHT WRENCH FOR THE JOB

COMBINATION SPANNERS

These combine in a single tool an open-ended jaw and a ring, both have the same dimension. The open-ended jaw is offset by 15° which enables the operator to turn any nut provided there is even a very small amount of access. The Bi-Hex (12 point) Ring end is also cranked at 15° from the horizontal, which enables you to grip the handle without risking injury to the knuckles.

OPEN-ENDED SPANNERS

Both ends of these spanners are open with the heads set at 15°. The open-ended format is ideal for working on pipelines where only side access is possible. Select slim open-ended jaws to give greater accessibility within the thickness of the fastener.

ADJUSTABLE WRENCH

This must be used carefully and sparingly if damage to the fastener is to be avoided, but it is still a very useful item for any toolkit.

COMBINATION SPANNER WITH RATCHETING RING END

A very useful specialist set of 6 spanners with the benefit of a ring end which ratchets with a 5° angle of engagement so that you can work in very restricted spaces and have the added advantage of an open ended end profile to work on fastenings that do not have 360° access as occurs on pipe work.

ACCELERATOR COMBINATION SPANNER

The open-end part of the tool incorporates an innovative jaw form which enables the user to engage and disengage without removing the spanner from the nut.

RATCHETS

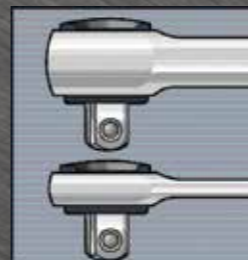

The turning force on the socket is imparted by the drive handle through a square recess forged into the end of the socket. The size of this recess varies depending on the size of the socket - 1/4" 3/8" or 1/2" square drive. Specific sets for each drive size are available, together with sets that combine drive sizes, which enable you to deal with fastenings from 4mm up to 32mm.

FatMax® and MicroTough™ ratchets offer the smoothest operation and allow access to fasteners in restricted areas. The smaller head is 20% - 30% smaller than standard ratchet heads and the fine tooth mechanism offers a 5° angle of engagement.

When working with oily hands it is important that the ratchet handle incorporates a quick socket release facility.

"Full Polish" Quick Release Ratchet

ISO 3315 / DIN 3122

- Full polish finish, double-nickel with chrome plating for extra rust resistance and prolonged life
- Fine-tooth pear head ratchet 1/4" dr - 45 tooth gear and 3/8" & 1/2" 54 tooth gear design for small 6.8 degree arc swing
- Thin Head design for accessibility
- Quick release push button provide extra safety and handy operation
- Reversing level designed for quick, one hand operation

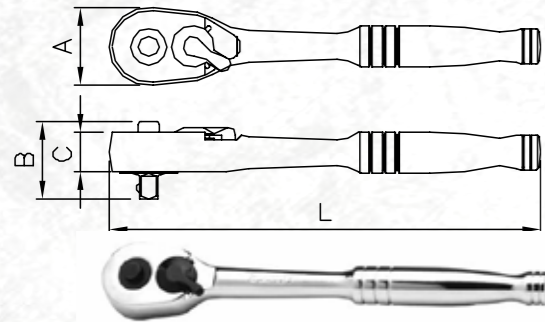

89-817

1/4"	SKU#	L mm	A mm	B mm	C mm	WEIGHT (g)	BOX/CTN
	89-817	143.0	24.5	21.3	11.5	125	4/48

3/8"	SKU#	L mm	A mm	B mm	C mm	WEIGHT (g)	BOX/CTN
	89-818	198.0	32.5	28.0	14.0	320	4/48

1/2"	SKU#	L mm	A mm	B mm	C mm	WEIGHT (g)	BOX/CTN
	89-819	253.0	41.0	35.3	18.0	586	4/24

Round Head Ratchet

- Full polish finish, double-nickel with chrome plating for extra rust resistance and prolonged life
- Round head ratchet for tight access area
- Anti-slip and durable knurled metal handle design suit most industrial applications
- Flip drive ratchet head for easy directional rotation

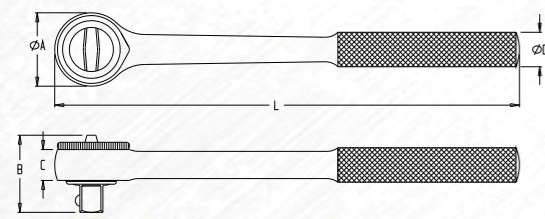

87-710

1/4"	SKU#	L mm	A mm	B mm	C mm	D mm	WEIGHT (g)	BOX/CTN
	87-710	146.0	26.0	28.0	11.8	12.7	150	4/48

3/8"	SKU#	L mm	A mm	B mm	C mm	D mm	WEIGHT (g)	BOX/CTN
	87-715	201.0	36.5	37.4	15.6	15.9	370	4/48

1/2"	SKU#	L mm	A mm	B mm	C mm	D mm	WEIGHT (g)	BOX/CTN
	87-720	256.0	43.5	43.9	17.6	19.0	620	4/48

Quick Release Ratchet - Round Head

ISO 3315 / DIN 3120

- Three way quick release ratchet head for directional rotation
- Round head ratchet for tight access area
- Comfortable and durable molded plastic handle withstands most industrial solvents
- Quick release push button provide extra safety and handy operation

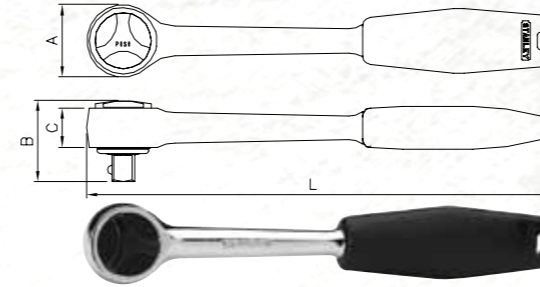

86-397-1

1/4"	SKU#	L mm	A mm	B mm	C mm	WEIGHT (g)	BOX/CTN
	86-395-1	150.0	26.0	29.0	13.5	150	4/48

3/8"	SKU#	L mm	A mm	B mm	C mm	WEIGHT (g)	BOX/CTN
	86-396-1	203.0	36.5	36.4	17.0	370	4/48

1/2"	SKU#	L mm	A mm	B mm	C mm	WEIGHT (g)	BOX/CTN
	86-397-1	265.0	41.0	46.1	21.9	620	4/48

Quick Release Ratchet - Pear Head

ISO 3315 / DIN 3122

- Chrome vanadium steel (Cr-V) forging, hardness toughness
- High torque output, more than 50% of the ANSI standard, powerful to use, reliable and durable
- 60-tooth ratchet head design, turn 6° can drive sleeve, suitable for narrow space
- There are pros and cons of rapid shedding and commutation function, easy operation
- Dual material handle, oil slip, comfortable grip

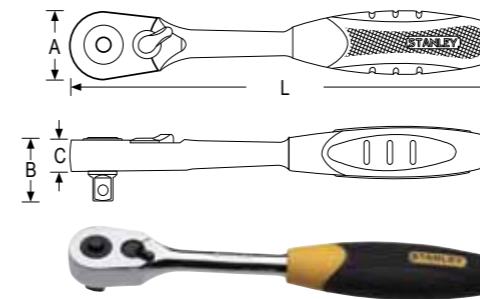

95-895

1/4"	SKU#	L mm	A mm	B mm	C mm	BOX/CTN
	95-895	144	20	22.1	9.9	4/48

3/8"	SKU#	L mm	A mm	B mm	C mm	BOX/CTN
	95-894	195	27	27.4	13.8	4/48

1/2"	SKU#	L mm	A mm	B mm	C mm	BOX/CTN
	95-893	240	32.5	35.7	16.5	4/48

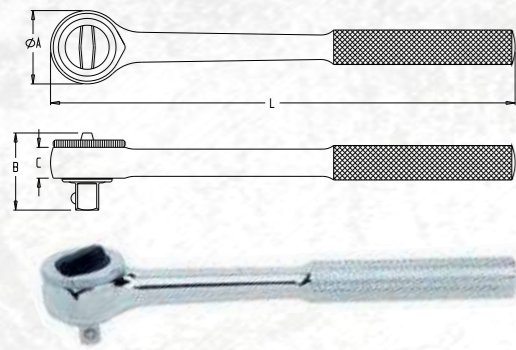

91-316

Drive Round Head Ratchet Knurled Handle

ISO 3315 / DIN 3122

- Forged from high quality steel and finished in high-polish chrome
- Articulation angle of 8.4°
- Knurled handle for comfort and anti-slip operation
- Sockets and extensions remain locked onto the drive until disengaged with an easy-to-reach low-profile quick-release button

3/4"	SKU#	L mm	A mm	B mm	C mm	BOX/CTN
	91-316	495	65	55	30	2/8

Offset Handle

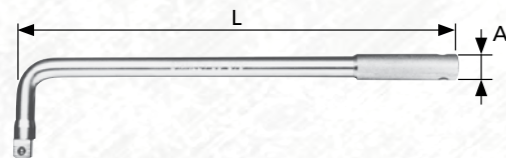

86-375

- Forged from high-quality steel and finished in high-polish chrome

3/4"	SKU#	L mm	A mm	BOX/CTN
	86-375	460.0	23.0	10/20

L-Handle

DIN 3122 / ISO 3315

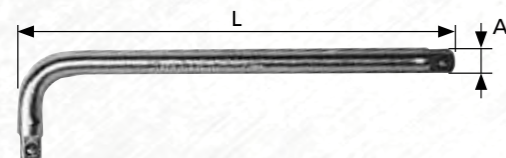

86-493

- Made of Chrome Vanadium Steel
- Sturdy construction to withstand high torque
- "L" shape protects hands during operation
- Allows access to hard-to-reach fasteners

1/2"	SKU#	L mm	A mm	WEIGHT (g)	BOX/CTN
	86-493	250.0	19.0	325	20/40

Sliding T-Bar

ISO 3315 / DIN 3122

- Made of Chrome Vanadium Steel
- Allows the application of high torque using both hands
- Place the socket adapter at the extremes of the bar for higher leverage

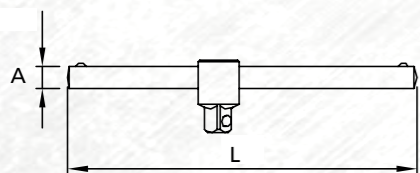

86-010-1

1/4"	SKU#	L mm	A mm	WEIGHT (g)	BOX/CTN
	86-010-1	108.0	6.4	38	6/96

3/8"	SKU#	L mm	A mm	WEIGHT (g)	BOX/CTN
	86-202-1	170.0	9.5	128	6/72

1/2"	SKU#	L mm	A mm	WEIGHT (g)	BOX/CTN
	86-440-1	243.0	12.7	289	4/32

3/4"	SKU#	L mm	A mm	WEIGHT (g)	BOX/CTN
	89-303-1	480.0	20.0	1400	2/18

Speeder Handle

ISO 3315 / DIN 3122

- Made of Chrome Vanadium Steel
- Facilitates the fast tightening or removal of fasteners, and provides easy access to hard-to-reach places

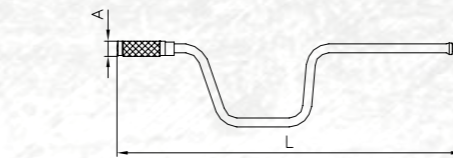

86-212

3/8"	SKU#	L mm	A mm	WEIGHT (g)	BOX/CTN
	86-212-1	380.0	17.0	328	6/18

1/2"	SKU#	L mm	A mm	WEIGHT (g)	BOX/CTN
	86-412-1	420.0	21.0	330	6/96

Flex Handle Bar

ISO 3315 / DIN 3122 (1/4" - 1/2")
ISO 1174 / DIN 3120 (3/4")

- Made of Chrome Vanadium Steel
- For applications where high leverage is needed to tighten or release a fastener

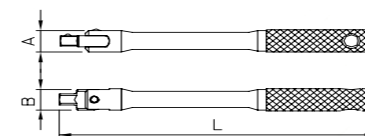

86-012-1

1/4"	SKU#	L mm	A mm	B mm	WEIGHT (g)	BOX/CTN
	86-012-1	147.0	12.7	12.0	92	6/48

3/8"	SKU#	L mm	A mm	B mm	WEIGHT (g)	BOX/CTN
	86-213-1	215.5	21.0	17.0	270	6/96

1/2"	SKU#	L mm	A mm	B mm	WEIGHT (g)	BOX/CTN
	86-413-1	439.0	28.0	20.1	713	6/36
	86-405-1	254.0	28.0	21.0	485	4/32
	86-415-1	381.0	28.0	21.0	646	6/24

3/4"	SKU#	L mm	A mm	B mm	WEIGHT (g)	BOX/CTN
	89-302-1	500.0	41.0	34.0	1850	2/16

Spinner

ISO 3315 / DIN 3122

- Adapts to socket to work as a nut driver

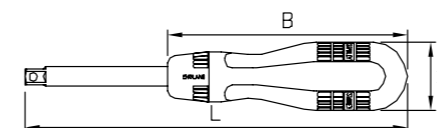

87-419-1

1/4"	SKU#	L mm	A mm	B mm	WEIGHT (g)	BOX/CTN
	87-419-1	146.0	21.0	90.0	60	6/48

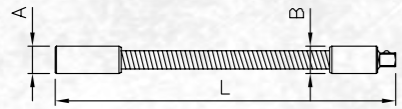

86-001-1

Flex Extension

- Made of Chrome Vanadium Steel
- Allows access to hard-to-reach fasteners
- Flexible body allows for adjusting and removal regardless of fastener location

1/4"	SKU#	SIZE	L mm	A mm	B mm	WEIGHT (g)	BOX/CTN
	86-001-1	6"	150.0	12.2	12.2	66	6/144

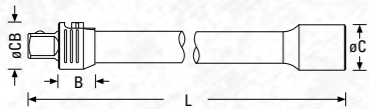

93-498

3/8" Drive Locking Extension

- Made of Chrome Vanadium Steel
- Locking device holds socket securely till job is done
- Solid 1-piece design
- Patented locking system

3/8"	SKU#	DESCRIPTION	L mm	A mm	B mm	BOX/CTN
	93-498	3" Extension	75	18	12.2	6/120
	93-499	6" Extension	150	18	12.2	6/120
	93-500	10" Extension	250	18	12.2	6/60

Extension Bar
ISO 3316 / DIN 3123

- Made of Chrome Vanadium Steel

1/4"	SKU#	SIZE	L mm	A mm	B mm	WEIGHT (g)	BOX/CTN
	91-059-1	2"	51.0	12.5	8.2	25	6/48
	86-006-1	3"	76.2	12.5	8.2	35	6/96
	91-339-1	4"	101.6	12.5	8.2	45	6/72
	86-007-1	6"	152.4	12.5	8.2	65	6/96
	86-372-1	10"	254.0	12.5	8.2	110	6/48

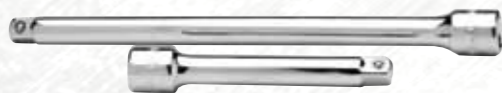
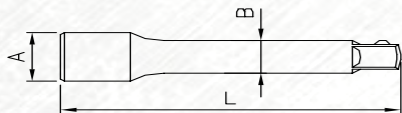

86-006-1

3/8"	SKU#	SIZE	L mm	A mm	B mm	WEIGHT (g)	BOX/CTN
	86-206-1	3"	76.2	17.0	12.2	75	6/96
	86-207-1	6"	152.4	17.0	12.2	145	6/96
	86-208-1	10"	245.0	17.0	12.2	235	6/72
	86-258-1	12"	306.0	17.0	12.2	280	6/48
	86-318-1	20"	508.0	17.0	12.2	470	6/48

1/2"	SKU#	SIZE	L mm	A mm	B mm	WEIGHT (g)	BOX/CTN
	86-406-1	2 1/2"	62.0	22.5	16.3	100	4/60
	88-930-1	3"	76.2	22.5	16.3	134	4/96
	86-407-1	5"	125.0	22.5	16.3	204	4/40
	86-408-1	10"	252.0	22.5	16.3	398	4/48
	88-729-1	20"	506.0	22.5	12.7	539	4/48

3/4"	SKU#	SIZE	L mm	A mm	WEIGHT (g)	BOX/CTN
	89-306-1	4"	102.0	35.5	405	4/32
	89-307-1	8"	203.0	35.5	700	4/24
	89-308-1	16"	406.0	35.5	1260	2/16

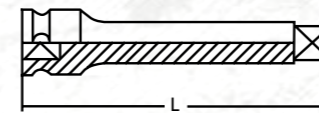

89-462-1

1/2" Drive Impact Extension Bar

- Provides strength and durability

1/2"	SKU#	L mm	WEIGHT (g)	BOX/CTN
	89-462-1	5	140	20/80

Universal Joint

ISO 3316 / IN 3123

- Made of Chrome Vanadium Steel

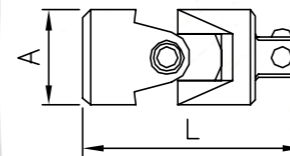

86-011-1

1/4"	SKU#	L mm	A mm	WEIGHT (g)	BOX/CTN
	86-011-1	34.0	14.0	25	12/96

3/8"	SKU#	L mm	A mm	WEIGHT (g)	BOX/CTN
	86-211-1	54.2	19.0	65	8/96

1/2"	SKU#	L mm	A mm	WEIGHT (g)	BOX/CTN
	86-411-1	68.5	24.9	165	4/96

3/4"	SKU#	L mm	A mm	WEIGHT (g)	BOX/CTN
	93-091-1	110.0	40.0	600	4/32

1/2" Drive Impact Universal Joint

- CR-Mo Strong Impact Resistance
- Meets ANSI Standards
- Black oxidized coating

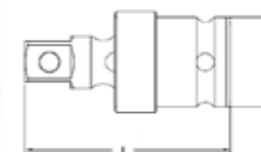

89-463

1/2"	SKU#	DESCRIPTION	D mm	L mm	WEIGHT (g)	BOX/CTN
	89-463	1/2" Universal Joint	28	65	160	20/80

Adapter

ISO 3316 / DIN 3120

- Made of Chrome Vanadium Steel
- Allows the use of a certain size drive ratchet with sockets of a different size

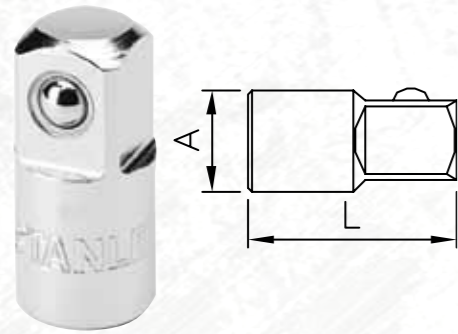

86-002-1

1/4"	SKU#	SIZE	L mm	A mm	WEIGHT (g)	BOX/CTN
	86-002-1	1/4"Fx3/8"M	25.0	12.2	18	12/96

3/8"	SKU#	SIZE	L mm	A mm	WEIGHT (g)	BOX/CTN
	86-214-1	3/8"Fx1/4"M	25.4	17.4	20	6/96
	86-215-1	3/8"Fx1/2"M	36.0	18.0	45	6/96

1/2"	SKU#	SIZE	L mm	A mm	WEIGHT (g)	BOX/CTN
	86-414-1	1/2"Fx3/8"M	34.5	22.0	48	6/96
	88-558-1	1/2"Fx3/4"M	42.0	25.2	113	6/96

3/4"	SKU#	SIZE	L mm	A mm	WEIGHT (g)	BOX/CTN
	88-908-1	3/4"Fx1/2"M	48.0	35.0	120	4/48
	88-909-1	3/4"Fx1"M	62.0	37.3	390	4/32

Bit Adapter

ISO 1174 / DIN 3120

- Forged from high-quality steel and finished in high-polish chrome
- Allows for the use of insert bits of 1/4" base with a ratchet or flex handle

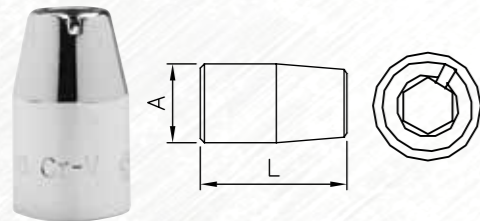

86-124-1

1/4"	SKU#	SIZE	L mm	A mm	WEIGHT (g)	BOX/CTN
	86-124-1	1/4" hex	25.2	24.2	25	12/96

3/8"	SKU#	SIZE	L mm	A mm	WEIGHT (g)	BOX/CTN
	86-250-1	1/4" hex	27	17.3	-	6/96

6 Point Standard Socket – Inch

ANSI B107.1

- Made of Chrome Vanadium Steel
- Chromed finish for exceptional resistance to rust.
- MaxiDrive™ gripping system: rounded gripping surface allows for 15% more torque and avoids rounding off fasteners, providing higher tenacity

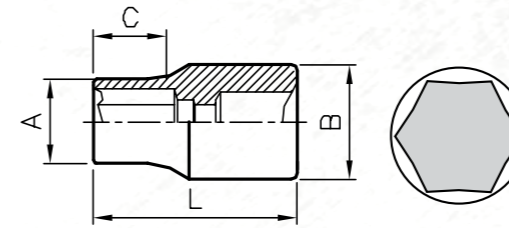

86-021-1

1/4"	SKU#	SIZE	L mm	A mm	B mm	C mm	WEIGHT (g)	BOX/CTN
	86-021-1	5/32"	25.0	6.9	12.0	3.6	10	12/96
	86-022-1	3/16"	25.0	8.0	12.0	3.6	12	12/96
	86-023-1	7/32"	25.0	8.8	12.0	4.2	12	12/96
	86-024-1	1/4"	25.0	10.0	12.0	4.8	12	12/96
	86-025-1	9/32"	25.0	10.9	12.0	4.0	13	12/96
	86-026-1	5/16"	25.0	12.0	12.0	4.0	13	12/96
	86-027-1	11/32"	25.0	13.2	13.2	4.5	18	12/96
	86-028-1	3/8"	25.0	14.7	14.4	4.5	19	12/96
	86-029-1	7/16"	25.0	16.0	16.0	6.0	22	12/96
	86-030-1	1/2"	25.0	17.7	17.7	7.2	28	12/96

1/2"	SKU#	SIZE	L mm	A mm	B mm	C mm	WEIGHT (g)	BOX/CTN
	86-384-1	1/4"	38.0	10.2	21.8	6.5	43	6/96
	86-441-1	5/16"	38.0	12.4	21.8	8.0	43	6/96
	86-442-1	3/8"	38.0	14.7	21.8	9.0	46	6/96
	86-443-1	7/16"	38.0	17.0	21.8	9.0	50	6/96
	86-444-1	1/2"	38.0	19.0	21.8	10.0	52	6/96
	86-445-1	9/16"	38.0	20.8	21.8	12.5	55	6/96
	86-446-1	19/32"	38.0	21.8	21.8	14.3	55	6/96
	88-766-1	5/8"	38.0	22.5	23.3	14.3	62	6/96
	88-767-1	11/16"	38.0	24.7	23.0	14.3	72	6/96
	88-768-1	3/4"	38.0	26.3	24.0	20.0	76	6/96
	86-450-1	25/32"	38.0	27.7	25.0	20.0	80	4/96
	88-769-1	13/16"	38.0	28.8	28.8	20.0	80	4/96
	88-770-1	7/8"	40.0	29.8	29.8	21.0	95	4/96
	88-771-1	15/16"	40.0	31.8	27.0	21.0	110	6/96
	88-772-1	31/32"	40.0	33.4	28.0	21.0	115	6/96
	88-773-1	1"	43.0	33.4	28.0	21.0	120	4/96
	88-774-1	1 1/16"	43.0	35.8	30.0	23.0	145	2/96
	88-775-1	1 1/8"	43.0	37.8	31.0	23.0	150	2/96
	86-458-1	1 3/16"	43.0	39.8	33.0	23.0	190	2/96
	88-776-1	1 1/4"	43.0	41.8	35.0	23.0	205	2/96

12-Point Deep Socket – Inch

ANSI B107.1

- Made of Chrome Vanadium Steel
- Chromed finish for exceptional resistance to rust
- MaxiDrive™ gripping system: rounded gripping surface allows for 15% more torque and avoids rounding off fasteners, providing higher tenacity

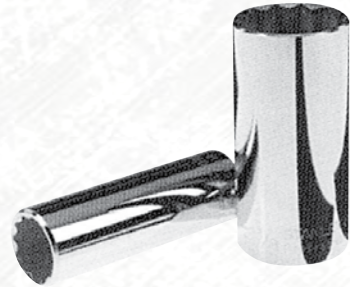
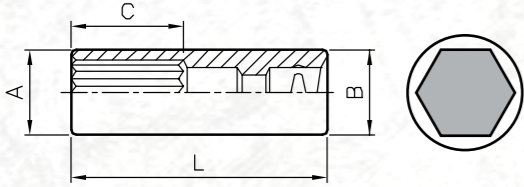

86-279-1

3/8"	SKU#	SIZE	L	A	B	C	WEIGHT	BOX/CTN
			mm	mm	mm	mm	(g)	
	86-279-1	1/4"	45.5	9.8	16.5	10.0	38	6/96
	91-284-1	5/16"	45.5	11.7	16.5	12.0	41	6/96
	91-286-1	3/8"	45.5	14.2	16.5	15.0	43	6/96
	91-287-1	7/16"	45.5	16.5	16.5	17.0	50	6/96
	91-288-1	1/2"	45.5	18.5	18.5	18.0	62	6/96
	91-289-1	9/16"	50.0	19.5	19.5	18.0	72	6/96
	91-296-1	5/8"	53.0	22.0	22.0	20.0	97	6/96
	91-297-1	11/16"	56.0	24.2	24.2	20.0	125	6/96
	91-298-1	3/4"	56.0	25.7	25.7	22.0	130	6/96
	91-302-1	13-16"	63.5	27.7	27.7	22.0	140	6/96

1/2"	SKU#	SIZE	L	A	B	C	WEIGHT	BOX/CTN
			mm	mm	mm	mm	(g)	
	86-481-1	1/2"	79.0	19.0	22.0	20.0	135	6/96
	86-482-1	9/16"	79.0	20.8	22.0	22.0	135	6/96
	86-483-1	5/8"	79.0	22.5	23.3	24.0	150	6/96
	86-484-1	11/16"	79.0	24.3	24.3	26.0	170	6/96
	86-485-1	3/4"	79.0	26.8	26.8	29.0	185	6/96
	86-486-1	13/16"	79.0	27.8	27.8	31.0	210	4/96
	86-487-1	7/8"	79.0	29.8	29.8	31.0	250	4/96
	86-488-1	15/16"	79.0	31.8	31.8	33.0	265	4/96
	86-489-1	1"	79.0	33.8	33.8	33.0	290	4/96
	86-490-1	1-1/16"	79.0	35.8	35.8	33.0	315	4/96
	86-491-1	1-1/8"	79.0	37.8	37.8	33.0	350	4/96

1/2" Drive Torx® Socket

- Made of Chrome Vanadium Steel
- To remove fasteners with Torx® shaped head

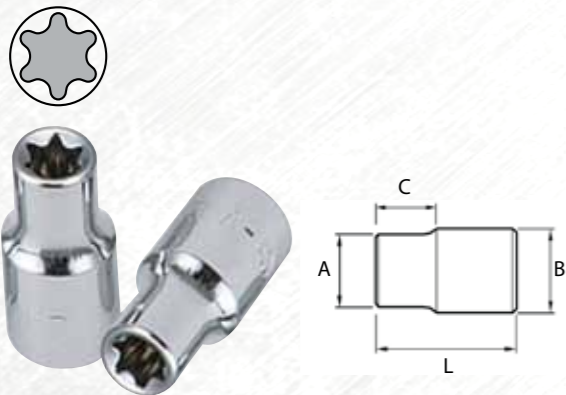

92-545-1

1/2"	SKU#	SIZE	L	A	B	C	BOX/CTN
			mm	mm	mm	mm	
	92-545-1	E10	38.0	13.3	21.8	10.0	6/96
	92-478-1	E12	38.0	15.0	21.8	12.0	6/96
	92-479-1	E14	38.0	17.0	21.8	12.0	6/96
	92-489-1	E16	38.0	18.5	21.8	12.0	6/96
	92-503-1	E18	38.0	20.0	21.8	12.0	6/96
	92-505-1	E20	38.0	23.3	21.8	13.0	6/96

Hex Bit Socket – Metric

ANSI B107

- Made of Chrome Vanadium Steel
- Chromed finish for exceptional resistance to rust
- MaxiDrive™ gripping system: rounded gripping surface allows for 15% more torque and avoids rounding off fasteners, providing higher tenacity
- Our sockets comply with the most stringent international standards: ANSI, DIN and ISO

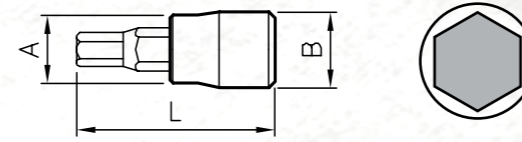

86-373-1

1/4"	SKU#	SIZE	L	A	B	WEIGHT	BOX/CTN
			mm	mm	mm	(g)	
	86-373-1	3	32.0	11.0	12.0	13	12/96
	86-721-1	4	32.0	11.0	12.0	13	12/96
	86-723-1	5	32.0	11.0	12.0	14	12/96
	86-725-1	6	32.0	11.0	12.0	15	12/96
	86-726-1	7	32.0	11.0	12.0	16	12/96
	86-727-1	8	32.0	11.0	12.0	16	12/96
	86-729-1	10	32.0	11.0	12.0	19	12/96

3/8"	SKU#	SIZE	L	A	B	WEIGHT	BOX/CTN
			mm	mm	mm	(g)	
	87-965-1	3	49.5	8.0	17.9	36	6/96
	87-971-1	4	49.5	10.0	17.9	37	6/96
	87-972-1	5	49.5	12.0	17.9	38	6/96
	87-973-1	6	49.5	14.0	17.9	38	6/96
	87-974-1	7	49.5	15.0	17.9	38	6/96
	87-975-1	8	49.5	16.0	17.9	40	6/96
	87-976-1	10	49.5	17.0	17.9	42	6/96

1/2"	SKU#	SIZE	L	A	B	WEIGHT	BOX/CTN
			mm	mm	mm	(g)	
	89-188-1	6	55.0	16.0	22.0	64	6/96
	89-189-1	8	55.0	16.0	22.0	74	6/96
	89-190-1	10	55.0	18.0	22.0	83	6/96
	89-191-1	12	55.0	19.0	22.0	94	6/96
	89-192-1	14	55.0	21.0	22.0	105	6/96
	89-193-1	17	55.0	24.4	24.4	143	6/96
	89-194-4	19	60.0	25.9	25.9	182	6/96

Torx® Temper-Resistant Bit Socket

- Made of Chrome Vanadium Steel
- Corrosion-Resistant Finish
- Iso Fits Standard Torx® Sizes: T and TS
- Perfect use for temper-proof star fasteners in today's cars, trucks and appliances
- Precision-machined tip for exact fit

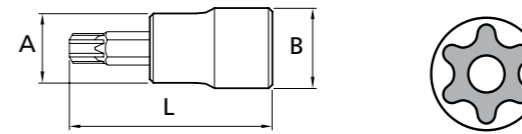

93-360-1

1/4"	SKU#	SIZE	L	A	B	BOX/CTN
			mm	mm	mm	
	93-360-1	T-10	55.0	14.0	22.0	6/96
	93-361-1	T-15	55.0	14.0	22.0	6/96
	93-362-1	T-20	55.0	14.0	22.0	6/96
	93-363-1	T-25	55.0	14.0	22.0	6/96
	93-364-1	T-27	55.0	14.0	22.0	6/96
	93-365-1	T-30	55.0	14.0	22.0	6/96
	93-366-1	T-40	55.0	14.0	22.0	6/96
	93-367-1	T-45	55.0	15.5	22.0	6/96
	93-368-1	T-50	55.0	15.5	22.0	6/96
	93-369-1	T-55	55.0	18.0	22.0	6/96
	93-370-1	T-60	55.0	19.2	22.0	6/96

Hex Bit Socket – Inch

- Made of Chrome Vanadium Steel
- Chromed finish for exceptional resistance to rust
- MaxiDrive™ gripping system: rounded gripping surface allows for 15% more torque and avoids rounding off fasteners, providing higher tenacity

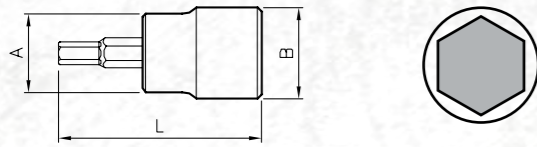

86-387-1

3/8"	SKU#	SIZE	L	A	B	WEIGHT	BOX/CTN
			mm	mm	mm	(g)	
	86-387-1	1/8"	49.5	8.0	17.9	36	6/96
	86-376-1	9/64"	49.5	9.5	17.9	37	6/96
	86-388-1	5/32"	49.5	10.0	17.9	38	6/96
	86-389-1	3/16"	49.5	12.0	17.9	38	6/96
	86-390-1	7/32"	49.5	13.0	17.9	38	6/96
	86-391-1	1/4"	49.5	14.0	17.9	40	6/96
	86-392-1	5/16"	49.5	16.0	17.9	40	6/96
	86-377-1	3/8"	49.5	17.0	17.9	42	6/144

1/2"	SKU#	SIZE	L	A	B	WEIGHT	BOX/CTN
			mm	mm	mm	(g)	
	89-180-1	5/16"	55.0	16.0	22.0	74	6/144
	89-181-1	3/8"	55.0	17.0	22.0	74	6/144
	89-182-1	7/16"	55.0	18.0	22.0	83	6/144
	89-183-1	1/2"	55.0	19.5	22.0	94	6/144
	89-184-1	9/16"	55.0	21.0	22.0	105	6/144
	89-185-1	5/8"	55.0	23.0	24.0	134	6/144

Long Hex Bit Socket - Metric
DIN 7422

- Made of Chrome Vanadium Steel
- Chromed finish for exceptional resistance to rust
- MaxiDrive™ gripping system: rounded gripping surface allows for 15% more torque and avoids rounding off fasteners, providing higher tenacity
- Our sockets comply with the most stringent international standards: ANSI, DIN and ISO

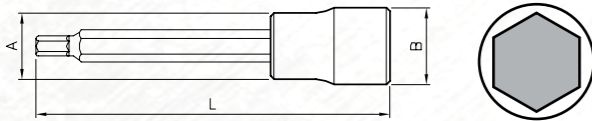

89-200-1

1/2"	SKU#	SIZE	L	A	B	WEIGHT	BOX/CTN
			mm	mm	mm	(g)	
	89-200-1	5	100.0	14.0	22.0	82	6/96
	89-201-1	6	100.0	14.0	22.0	82	6/96
	89-202-1	7	100.0	15.0	22.0	85	6/96
	89-203-1	8	100.0	16.0	22.0	90	6/96
	89-204-1	10	100.0	18.0	22.0	105	6/96
	89-205-1	12	100.0	19.0	22.0	135	6/96

Torx® Bit Socket

- Made of Chrome Vanadium Steel
- Chromed finish for exceptional resistance to rust
- MaxiDrive™ gripping system: rounded gripping surface allows for 15% more torque and avoids rounding off fasteners, providing higher tenacity



91-576-1

1/4"	SKU#	SIZE	L	A	B	BOX/CTN
			mm	mm	mm	
	91-576-1	T-08	32.0	11.0	12.0	6/144
	91-577-1	T-10	32.0	11.0	12.0	6/144
	91-578-1	T-15	32.0	11.0	12.0	6/144
	91-579-1	T-20	32.0	11.0	12.0	6/144
	91-580-1	T-25	32.0	11.0	12.0	6/144
	91-582-1	T-30	32.0	11.0	12.0	12/144
	91-583-1	T-40	32.0	11.0	12.0	6/144

3/8"	SKU#	SIZE	L	A	B	BOX/CTN
			mm	mm	mm	
	87-404-1	T-10	49.5	8.0	17.9	6/96
	87-141-1	T-15	49.5	10.0	17.9	6/96
	87-142-1	T-20	49.5	12.0	17.9	6/96
	87-143-1	T-25	49.5	14.0	17.9	6/96
	87-406-1	T-27	49.5	15.0	17.9	6/96
	87-144-1	T-30	49.5	16.0	17.9	6/96
	87-145-1	T-40	49.5	16.0	17.9	6/96
	87-146-1	T-45	49.5	16.0	17.9	6/96
	87-147-1	T-50	49.5	17.0	17.9	6/96
	87-407-1	T-55	49.5	17.0	17.9	6/96

1/2"	SKU#	SIZE	L	A	B	BOX/CTN
			mm	mm	mm	
	89-215-1	T-20	55.0	14.0	22.0	6/96
	89-216-1	T-25	55.0	14.0	22.0	6/96
	89-217-1	T-27	55.0	14.0	22.0	6/96
	89-218-1	T-30	55.0	14.0	22.0	6/96
	89-219-1	T-40	55.0	14.0	22.0	6/96
	89-230-1	T-45	55.0	16.0	22.0	6/96
	89-231-1	T-50	55.0	16.0	22.0	6/96
	89-232-1	T-55	55.0	18.0	22.0	6/96
	89-233-1	T-60	55.0	19.0	22.0	6/96

Phillips® Bit Socket

- Made of Chrome Vanadium Steel
- Chromed finish for exceptional resistance to rust
- MaxiDrive™ gripping system: rounded gripping surface allows for 15% more torque and avoids rounding off fasteners, providing higher tenacity



86-176-1

1/4"	SKU#	SIZE	L	A	B	BOX/CTN
			mm	mm	mm	
	89-063-1	1 PT	32.0	11.0	12.0	6/144
	89-064-1	2 PT	32.0	11.0	12.0	6/144
	89-065-1	3 PT	32.0	11.0	12.0	6/144

3/8"	SKU#	SIZE	L	A	B	BOX/CTN
			mm	mm	mm	
	86-176-1	0 PT	49.5	14.0	17.9	6/144
	86-335-1	1 PT	49.5	14.0	17.9	6/144
	86-177-1	2 PT	49.5	14.0	17.9	6/144
	86-336-1	3 PT	49.5	14.0	17.9	6/96
	86-178-1	4 PT	49.5	14.0	17.9	6/144

Slotted Bit Socket – Metric

ISO 2380 / DIN 5264

- Made of Chrome Vanadium Steel
- Chromed finish for exceptional resistance to rust
- MaxiDrive™ gripping system: rounded gripping surface allows for 15% more torque and avoids rounding off fasteners, providing higher tenacity

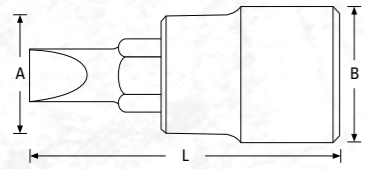

89-154-1

1/4"	SKU#	SIZE	L	A	B	WEIGHT	BOX/CTN
			mm	mm	mm	(g)	
	86-374-1	3.5	32.0	11.0	12.0	12	6/144
	86-745-1	4	32.0	11.0	12.0	13	6/144
	86-743-1	5.5	32.0	11.0	12.0	13	6/144
	86-744-1	6.5	32.0	11.0	12.0	13	6/144
	86-747-1	7	32.0	11.0	12.0	14	6/144
	86-297-1	8	32.0	11.0	12.0	14	6/144

3/8"	SKU#	SIZE	L	A	B	WEIGHT	BOX/CTN
			mm	mm	mm	(g)	
	89-150-1	3.5	49.5	14.0	17.9	33	6/144
	89-151-1	4	49.5	14.0	17.9	36	6/144
	89-152-1	4.5	49.5	14.0	17.9	36	6/144
	89-153-1	5.5	49.5	14.0	17.9	36	6/144
	89-154-1	6.5	49.5	14.0	17.9	37	6/144
	89-155-1	7	49.5	14.0	17.9	37	6/144
	89-156-1	8	49.5	16.0	17.9	42	6/144
	89-157-1	10	49.5	16.0	17.9	45	6/144

1/2"	SKU#	SIZE	L	A	B	WEIGHT	BOX/CTN
			mm	mm	mm	(g)	
	89-208-1	6.5	55.0	16.0	22.0	74	6/144
	89-209-1	8	55.0	16.0	22.0	74	6/144
	89-210-1	10	55.0	18.0	22.0	76	6/144
	89-211-1	12	55.0	19.0	22.0	80	6/144

Torx® Bit Socket - 100mm

- Made of Chrome Vanadium Steel
- Chromed finish for exceptional resistance to rust
- MaxiDrive™ gripping system: rounded gripping surface allows for 15% more torque and avoids rounding off fasteners, providing higher tenacity

(Torx® is a registered trademark of Textron, Inc. d/b/a The Camcar Screw & Mfg. Company)

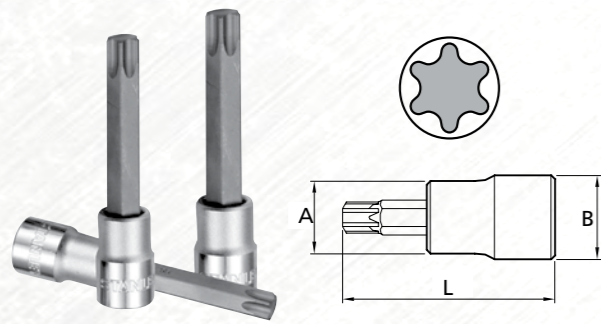

89-991-1

1/2"	SKU#	SIZE	L	A	B	BOX/CTN
			mm	mm	mm	
	89-991-1	T-30	100.0	14.0	22.0	6/48
	89-992-1	T-40	100.0	14.0	22.0	6/48
	89-993-1	T-45	100.0	15.5	22.0	6/48
	89-994-1	T-50	100.0	15.5	22.0	6/48
	89-995-1	T-55	100.0	18.0	22.0	6/48
	89-998-1	T-60	100.0	19.2	22.0	6/48

Pozidriv® Bit Socket

- Made of Chrome Vanadium Steel
- Chromed finish for exceptional resistance to rust
- MaxiDrive™ gripping system: rounded gripping surface allows for 15% more torque and avoids rounding off fasteners, providing higher tenacity

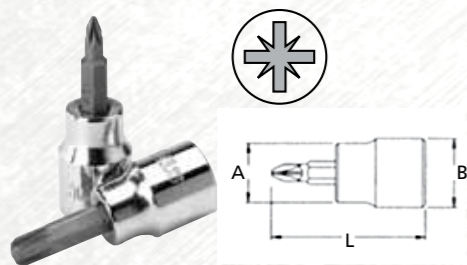

89-170-1

3/8"	SKU#	SIZE	L	A	B	WEIGHT	BOX/CTN
			mm	mm	mm	(g)	
	89-170-1	0 PT	49.5	14.0	17.9	37	6/144
	89-171-1	1 PT	49.5	14.0	17.9	37	6/144
	89-172-1	2 PT	49.5	14.0	17.9	37	6/144
	89-173-1	3 PT	49.5	14.0	17.9	38	6/144
	89-174-1	4 PT	49.5	14.0	17.9	38	6/144

6 Point Spark Plug Sockets - Metric / Inch

- Made of Chrome Vanadium Steel
- Chromed finish for exceptional resistance to rust



86-380-1

3/8"	SKU#	SIZE	L	A	WEIGHT	BOX/CTN
			mm	mm	(g)	
	86-380-1	5/8"	64.0	22.0	100	6/96
	86-381-1	13/16"	70.0	28.0	16	4/96

1/2"	SKU#	SIZE	L	A	WEIGHT	BOX/CTN
			mm	mm	(g)	
	86-580-1	5/8"	64.0	23.0	130	4/96
	86-581-1	13/16"	70.0	28.0	165	4/48
	86-582-1	14mm	77.0	22.0	141	4/72
	86-583-1	16mm	65.0	65.0	97	4/72
	86-584-1	18mm	77.0	26.0	151	4/72
	86-585-1	21mm	70.0	65.0	146	4/72

T-handle Fixed Head 6 Point Sockets

- Made of Chrome Vanadium Steel
- Chromed finish for exceptional resistance to rust



93-302-1

SKU#	DESCRIPTION	BOX/CTN
93-302-1	T-Handle 6pt Socket 08mm x L300mm	50/50
93-303-1	T-Handle 6pt Socket 09mm x L300mm	50/50
93-304-1	T-Handle 6pt Socket 10mm x L300mm	50/50
93-305-1	T-Handle 6pt Socket 11mm x L300mm	50/50
93-306-1	T-Handle 6pt Socket 12mm x L300mm	50/50
93-307-1	T-Handle 6pt Socket 13mm x L300mm	40/40
93-308-1	T-Handle 6pt Socket 14mm x L300mm	40/40
93-309-1	T-Handle 6pt Socket 17mm x L300mm	30/30
93-311-1	T-Handle 6pt Socket 19mm x L300mm	35/35
95-744-1	T-Handle 6pt Socket 16mm x L300mm	35/35
95-745-1	T-Handle 6pt Socket 18mm x L300mm	35/35
95-746-1	T-Handle 6pt Socket 21mm x L300mm	30/30

T-handle Flex Head 6 Point Sockets

- Made of Chrome Vanadium Steel
- Chromed finish for exceptional resistance to rust



79-076

SKU#	DESCRIPTION	BOX/CTN
79-076	T-Handle Flex Head 6pt Socket - 08mm x L500mm	40/40
79-077	T-Handle Flex Head 6pt Socket - 09mm x L500mm	40/40
79-078	T-Handle Flex Head 6pt Socket - 10mm x L500mm	40/40
79-079	T-Handle Flex Head 6pt Socket - 12mm x L500mm	40/40
79-080	T-Handle Flex Head 6pt Socket - 13mm x L500mm	40/40
79-081	T-Handle Flex Head 6pt Socket - 14mm x L500mm	40/40
79-082	T-Handle Flex Head 6pt Socket - 17mm x L500mm	40/40
79-083	T-Handle Flex Head 6pt Socket - 19mm x L500mm	40/40
79-084	T-Handle Flex Head 6pt Socket - 21mm x L500mm	30/30

Slimline 9 Piece Combination Wrench Set

ISO 3318 / DIN 3113

- Made of Chrome Vanadium Steel
- Both the open ended head and the ring are angled at 15° for optimum accessibility
- Nickel chrome plating protects against corrosion
- Slim pattern
- MaxiDrive™ and anti-slip open ended jaw shape maintains grip on fastener with only slight rotational pressure
- Anti-slip feature

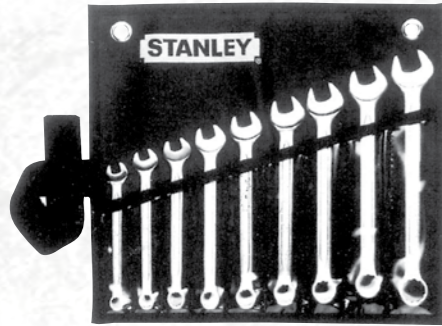

87-033-1

SKU#	CONTENTS	WEIGHT (g)	BOX/CTN
87-034-1	"Slimline" wrench: 8, 9, 10, 11, 12, 13, 14, 15, 17mm Heavy-duty nylon pouch Inner box	910	20/20
87-033-1	"Slimline" wrench: 10, 11, 12, 13, 14, 15, 16, 17, 19mm Heavy-duty nylon pouch Inner box	1490	16/16

Slimline 14 Piece Combination Wrench Set

ISO 3318 / DIN 3113

- Made of Chrome Vanadium Steel
- Both the open ended head and the ring are angled at 15° for optimum accessibility
- Nickel chrome plating protects against corrosion
- Slim pattern
- MaxiDrive™ and anti-slip open ended jaw shape maintains grip on fastener with only slight rotational pressure
- Anti-slip feature

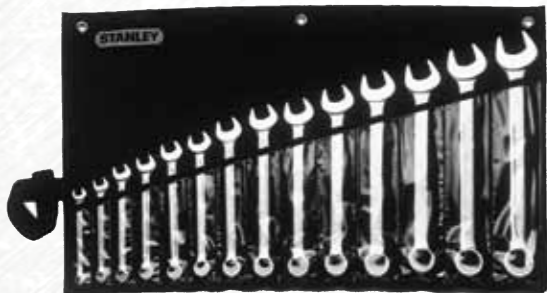

87-036-1

SKU#	CONTENTS	WEIGHT (g)	BOX/CTN
87-036-1	"Slimline" wrench: 8, 9, 10, 11, 12, 13, 14, 15, 16, 17, 19, 21, 22, 24mm Heavy-duty nylon pouch Inner box	3600	10/10
87-038-1	"Slimline" wrench: 10, 11, 12, 13, 14, 17, 19, 21, 22, 23, 24, 26, 30, 32mm Heavy-duty nylon pouch Inner box	2300	1/6
87-709-1	"Slimline" wrench: 3/8", 7/16", 1/2", 9/16", 5/8", 11/16", 3/4", 13/16", 7/8", 15/16", 1", 1 1/16", 1 1/8", 1 1/4" Heavy-duty nylon pouch Inner box	10400	1/6

75° Offset Ring End Wrench Set

ISO 1711 / DIN 838 / 1085

- Double ring wrench chrome vanadium steel
- MaxiDrive™ Plus profile - Attacks on the sides, not the corners of the nut or bolt
- Twelve-edged head for optimal support of hexagonal and square nuts
- Polished and chrome-plated finish for excellent protection
- Heads to 70° for greater access in tight spaces
- Powerful and safe working
- Anti-slip feature



87-576-1

SKU#	CONTENTS	WEIGHT (g)	BOX/CTN
87-576-1 8 pc	"Slimline" wrench: (Metric) 6 x 7, 8 x 9, 10 x 11, 12 x 13, 14 x 15, 16 x 17, 18 x 19, 20 x 22mm Inner box	1400	12/12
87-617-1 10 pc	"Slimline" wrench: (Metric) 6 x 7, 8 x 9, 10 x 11, 12 x 13, 14 x 15, 16 x 17, 18 x 19, 20 x 22, 21 x 23, 24 x 27mm Inner box	2200	10/10
87-714 7 pc	"Slimline" wrench: (Inch) 1/4" x 5/16", 3/8" x 7/16", 7/16" x 1/2", 9/16" x 5/8", 11/16" x 3/4", 13/16" x 7/8", 1" x 1-1/8" Heavy-duty nylon pouch, Inner box	1800	1/4

12-Piece Slimline Combination Wrench Set - Metric

- Made of Chrome Vanadium Steel
- Both the open ended head and the ring are angled at 15° for optimum accessibility
- Nickel chrome plating protects against corrosion
- Slim pattern
- MaxiDrive™ and anti-slip open ended jaw shape maintains grip on fastener with only slight rotational pressure
- Anti-slip feature

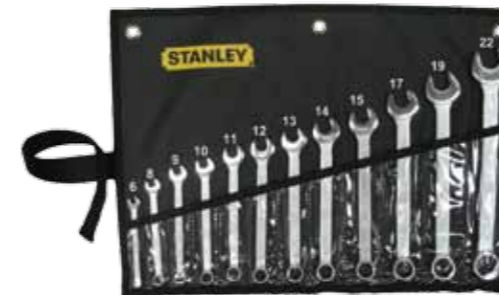

95-094-1

6	100.0	4.7	10.1	4.0	15.5	7.1	2.7	15	1/10
8	120.0	5.5	12.8	4.5	19.2	8.4	3.0	23	1/10
9	130.0	5.9	14.2	4.5	21.2	9.0	3.3	33	1/10
10	140.0	6.5	15.6	5.0	23.2	9.6	3.5	38	1/10
11	150.0	6.9	16.9	5.4	25.3	10.4	3.7	50	1/10
12	160.0	7.3	18.3	5.5	27.2	11.3	3.9	58	1/10
13	170.0	7.8	19.7	5.9	29.4	12.1	4.1	66	1/10
14	180.0	8.3	21.2	6.2	31.5	12.9	4.4	88	1/10
15	190.0	8.6	22.5	6.4	33.2	13.5	4.6	96	1/10
17	210.0	9.3	25.3	6.9	36.5	14.6	5.0	124	1/10
19	230.0	10.5	28.1	7.4	40.7	15.9	5.4	169	1/10
22	260.0	11.5	32.6	8.2	46.9	18.0	5.8	212	1/10



89-897A

117-Piece Wrench Merchandizer Set - Metric

- 6 sets of "Slimline" combination wrench :
6, 7, 8, 9, 10, 11, 12, 13, 14, 15, 16, 17, 18, 19mm
- 4 sets of "Slimline" combination wrench :
21, 22, 24, 27, 25, 26, 30, 32mm
- Merchandizer Board
- Anti-slip feature

SKU#	DESCRIPTION	BOX/CTN
89-897A	117-Piece Wrench Merchandizer Set - Metric	1/1

40° Offset Ring Wrenches

ISO 1711 / DIN 838

- Double ring wrench chrome vanadium steel
- Maxi Drive Plus profile - Attacks on the sides, not the corners of the nut or bolt
- Twelve-edged head for optimal support of hexagonal and square nuts
- Polished and chrome-plated finish for excellent protection
- Powerful and safe working

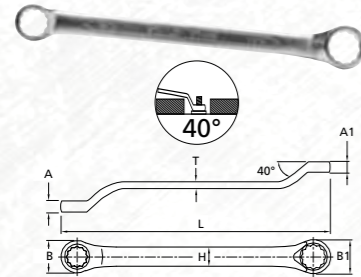

86-127

SKU#	SIZE	L mm	A mm	A1 mm	B mm	B1 mm	H mm	T mm	BOX/CTN
86-127	8x9	170	6.0	5.5	16.5	14.5	8.8	4.0	50/250
93-621	8x10	170	6.0	5.5	16.5	14.5	8.8	4.0	50/250
93-622	10x12	195	7.0	6.5	19.2	17.2	9.8	4.3	50/250
93-623	11x13	206	8.0	7.5	22.0	20.0	11.8	5.1	50/250
93-624	12x14	206	8.0	7.5	22.0	20.0	11.8	5.1	50/250
93-625	14x17	237	9.5	9.0	26.0	24.0	13.8	5.6	20/100
93-626	17x19	270	11.0	10.5	29.5	28.0	15.8	7.3	20/100
93-627	19x21	292	11.7	11.2	32.5	29.0	16.6	7.6	20/100
86-896	21x23	346	12.5	12.0	34.8	32.8	18.4	8.0	25/50
93-628	22x24	346	12.5	12.0	34.8	32.8	18.4	8.0	25/50
93-629	23x26	362	13.0	12.5	36.5	34.5	19.8	8.3	25/50
95-880	24x27	410	15.5	15.0	42.7	38.2	21.8	9.3	5/20
95-881	30x32	465	18.0	17.5	47.2	43.5	24.8	10.3	5/20

75° Offset Ring End Wrench

ISO 1711 / DIN 838/ 1085

- Double ring wrench chrome vanadium steel
- MaxiDrive™ Plus profile - Attacks on the sides, not the corners of the nut or bolt
- Twelve-edged head for optimal support of hexagonal and square nuts
- Polished and chrome-plated finish for excellent protection
- Heads to 70° for greater access in tight spaces
- Powerful and safe working

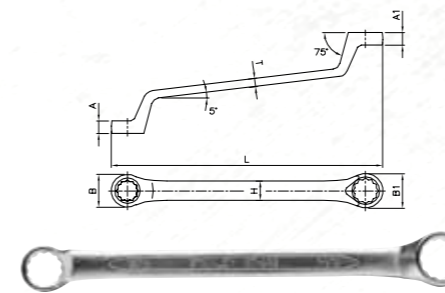

87-801-1

SKU#	SIZE	L mm	A mm	A1 mm	B mm	B1 mm	H mm	T mm	BOX/CTN
87-801-1	6x7	168.0	5.7	6.3	10.7	12.2	8.0	4.1	6/60
87-802-1	8x9	183.0	6.6	7.0	13.6	15.1	9.3	4.5	6/24
87-803-1	10x11	198.0	7.4	7.7	16.6	18.0	11.3	4.9	6/24
87-804-1	12x13	217.0	8.1	8.4	19.5	20.9	13.0	5.4	6/72
87-805-1	14x15	239.0	8.8	9.1	22.4	23.7	13.8	5.7	6/48
87-806-1	16x17	260.0	9.5	9.8	25.3	26.7	15.0	6.2	6/48
87-807-1	18x19	292.0	10.1	10.4	28.2	29.7	16.0	6.6	6/48
87-808-1	20x22	318.0	10.9	11.4	31.1	34.0	17.6	7.1	4/24
87-809-1	21x23	326.5	11.2	11.6	32.6	35.5	18.0	7.6	4/24
87-810-1	24x27	329.0	12.4	13.4	36.9	41.0	20.0	8.1	4/24
87-811-1	25x28	347.0	12.7	13.7	38.4	42.8	20.6	8.5	2/16
87-812-1	30x32	362.0	14.4	15.2	45.5	48.5	21.5	9.0	2/16

SKU#	SIZE	L mm	A mm	A1 mm	B mm	B1 mm	H mm	T mm	BOX/CTN
87-687-1	1/4"x5/16"	168.0	5.6	6.3	10.7	12.2	8.0	4.1	6/24
87-688-1	15/16"x3/8"	183.0	6.6	7.0	13.6	15.1	9.3	4.5	6/24
87-689-1	3/8"x7/16"	198.0	7.4	7.7	16.6	18.0	11.3	4.9	6/24
87-690-1	7/16"x1/2"	217.0	8.1	8.4	19.5	20.9	13.0	5.4	6/24
87-691-1	9/16"x5/8"	239.0	8.8	9.1	22.4	23.7	13.8	5.7	6/24
87-692-1	5/8"x11/16"	260.0	9.5	9.8	25.3	26.7	15.0	6.2	6/24
87-693-1	11/16"x3/4"	292.0	10.1	10.4	28.2	29.7	16.0	6.6	6/24
87-694-1	13/16"x7/8"	318.0	10.9	11.4	31.1	34.0	17.6	7.1	4/24
87-695-1	15/16"x1 1/16"	329.0	12.4	13.4	36.9	41.0	20.0	8.1	4/24
87-696-1	1"x1 1/8"	347.0	12.7	13.7	38.4	42.8	20.6	8.5	2/12
87-697-1	1 1/8"x1 1/4"	362.0	14.4	15.2	45.5	48.5	21.5	9.0	2/12



1/2" Impact Wrench 813Nm

- End cap slider-guide trigger - designed for easy operation
- Improved throttle valve seat - allows easier maintenance
- Composite grip - super lightweight, ergonomic design isolating from the coldness
- Improved air inlet - effectively reduces the damage and loss of thread
- Three-speed control for forward and one-speed full output for reverse direction
- Patented three-way air inlet function - increase 10% and more at horsepower delivery than same level tools
- **Service Kit Content :**
O-ring 9, Spring 2, Steel ball 1, Ball-bearing 2, Rotor blade 6, Gasket 1

SKU#	SQUARE DRIVE inch	STANDARD BOLT Size inch	FREE SPEED RPM	MAX. TORQUE Nm	OVERALL LENGTH mm	AIR INLET PT	AIR HOSE I.D	AVG. AIR CONSUMPTION cfm (l/min)	NOISE LEVEL dB	NET WEIGHT (kg)	SERVICE KIT	BOX/ CTN
79-089	1/2	3/4	8,000	813	193	1/4	3/8	4.4 (125)	83.79	2.15	79-089RK	1/8



1/2"(542Nm) & 3/4"(813Nm) Impact Wrench

- Built-in regulator
- Twin hammer mechanism for durability
- forward/ reverse directional control and variable speed trigger
- Applicable for automotive service centre
- **89-474 Service Kit Content :**
O-ring 5, Spring 3, Steel ball 2, Ball-bearing 2, Retainer 1, Rotor blade 6, Gasket 2, Socket retainer 1
- **89-475 Service Kit Content :**
O-ring 5, Spring 3, Steel ball 2, Ball-bearing 2, Retainer 1, Rotor blade 6, Gasket 2, Socket retainer 1, Muffler element 1

SKU#	SQUARE DRIVE inch	STANDARD BOLT Size inch	FREE SPEED RPM	MAX. TORQUE Nm	OVERALL LENGTH mm	AIR INLET PT	AIR HOSE I.D	AVG. AIR CONSUMPTION cfm (l/min)	NOISE LEVEL dB	NET WEIGHT (kg)	SERVICE KIT	BOX/ CTN
89-474	1/2	5/8	8,000	542	186	1/4	3/8	4 (113)	97.93	2.56	89-474RK	1/8
89-475	3/4	53/64	7,500	813	217	1/4	3/8	6.5 (184)	98.11	3	89-475RK	1/4

1/4" Angle Grinder

- Suitable for all workshops
- Easy to access into confined areas
- Ideal for grinding, edge-breaking, debarring, porting and polishing
- Swivel exhaust
- Adjustable regulator



SKU#	COLLET DRIVE inch	STANDARD BOLT Size inch	FREE SPEED RPM	MAX. TORQUE Nm	OVERALL LENGTH mm	AIR INLET PT	AIR HOSE I.D	AVG. AIR CONSUMPTION cfm (l/min)	NOISE LEVEL dB	NET WEIGHT (kg)	SERVICE KIT	BOX/ CTN
78-413	1/4	-	20,000	-	176	1/4	3/8	2 (57)	96.8	0.57	N.A.	2/4



3/8" Drive Reversible Keyless Air Drill

- Lightweight, balanced 3/8" drill great for most applications
- Reversible
- Variable speed trigger control
- 3/8" Jacobs Keyless Chuck
- Easy access forward/reverse lever
- Textured grip

89-472

SKU#	SQUARE DRIVE inch	STANDARD BOLT Size inch	FREE SPEED RPM	MAX. TORQUE Nm	OVERALL LENGTH mm	AIR INLET PT	AIR HOSE I.D	AVG. AIR CONSUMPTION cfm (l/min)	NOISE LEVEL dB	NET WEIGHT (kg)	SERVICE KIT	BOX/ CTN
89-472	-	-	1,800	-	193.7	1/4	3/8	5.2 (147)	90	1.7	N.A.	1/10



6" Dual Action Sander, 10k rpm

- Lock off throttle for prevention of accidents
- Comfort insulated grip
- Velcro type design for pad
- Bottom exhaust

78-341

SKU#	PAD SIZE inch	ORBITAL OPTION inch	FREE SPEED RPM	MAX. TORQUE Nm	OVERALL LENGTH mm	AIR INLET PT	AIR HOSE I.D	AVG. AIR CONSUMPTION cfm (l/min)	NOISE LEVEL dB	NET WEIGHT (kg)	SERVICE KIT	BOX/ CTN
78-341	6	5	10,000	-	220	1/4	3/8	2.6 (74)	88	1.5	N.A.	1/2



4" Angle Grinder / Cutter

- Spindle lock design
- Spindle thread
- Front exhaust
- Safety lever
- Swivel guard adjustable in 9 positions
- ANSI standard
- One-year limited warranty
- **Service Kit Content :**
 - * Ball Bearing
 - * Rotor Blade
 - * Bevel Gear 1
 - * Bevel Gear 2
 - * Spring, Safety Lever
 - * Spring Pin

78-032

SKU#	SQUARE DRIVE inch	HORSE POWER	DISC SIZE inch (mm)	FREE SPEED RPM	SPINDLE SIZE	OVERALL LENGTH mm	AIR INLET PT	AIR HOSE I.D	AVG. AIR CONSUMPTION cfm (l/min)	NOISE LEVEL dB	NET WEIGHT (kg)	SERVICE KIT	BOX/ CTN
78-032	-	0.8	4"(100mm)	12,000	M10x1.5	238	1/4	3/8	3 (85)	87	2.0	78-032RK	10/10

7" Angle Grinder / Cutter



- Spindle lock design
- Spindle thread
- Front exhaust
- Safety lever
- Swivel guard adjustable in 9 positions
- ANSI standard
- One-year limited warranty
- **Service Kit Content :**
 - * Rotor Blade 4
 - * Pinion Gear 1
 - * Bevel Gear 1
 - * Ball Bearing 2

SKU#	SQUARE DRIVE inch	HORSE POWER	DISC SIZE inch (mm)	FREE SPEED RPM	SPINDLE SIZE	OVERALL LENGTH	AIR INLET PT	AIR HOSE I.D.	AVG. AIR CONSUMPTION cfm (l/min)	NOISE LEVEL dB	NET WEIGHT (kg)	SERVICE KIT	BOX/CTN
79-033	-	1.3	7"(175mm)	7,500	5/8	350	3/8	3/8	5 (142)	97	3.5	78-033RK	6/24

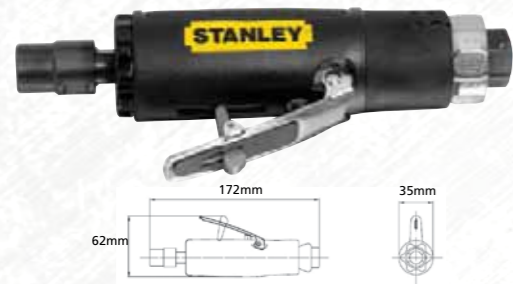

1/4" Mini Die Grinder

- Lightweight housing
- Durable bearing and smooth operation
- Safety trigger to prevent accident
- Suitable for professional users
- Adjustable regulator
- 360° Swivel Exhaust

SKU#	COLLET DRIVE inch	STANDARD BOLT Size inch	FREE SPEED RPM	MAX. TORQUE Nm	OVERALL LENGTH mm	AIR INLET PT	AIR HOSE I.D.	AVG. AIR CONSUMPTION cfm (l/min)	NOISE LEVEL dB	NET WEIGHT (kg)	SERVICE KIT	BOX/CTN
78-340	1/4	-	25,000	-	170	1/4	3/8	2.3 (65)	90	0.4	N.A.	2/4



Power Chisel With Hexagonal Shank, 3.6k rpm

- Ideal for various automotive
- Designed for cutting metals, chipping and scraping surfaces
- 3 chisels included
- Handle exhaust

SKU#	SHANK OPENING inch	PISTON STROKE inch	FREE SPEED RPM	MAX. TORQUE Nm	OVERALL LENGTH mm	AIR INLET PT	AIR HOSE I.D.	AVG. AIR CONSUMPTION cfm (l/min)	NOISE LEVEL dB	NET WEIGHT (kg)	SERVICE KIT	BOX/CTN
78-339	0.401	2 - 5/8	3,500	-	172	1/4	3/8	2.7 (77)	93	1.4	N.A.	1/2

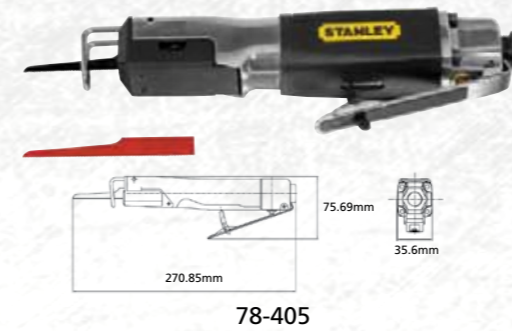

Reciprocating Air Saw, 10k rpm

- Ideal for body repair workshop
- Safety trigger function
- Cut tight radius curves on flat
- Suitable for cutting all types of sheet metal, Fibreglass, aluminium and plastic
- Front exhaust

SKU#	CUTTING CAPACITY (mm)		FREE SPEED RPM	MAX. TORQUE Nm	OVERALL LENGTH mm	AIR INLET PT	AIR HOSE I.D.	AVG. AIR CONSUMPTION cfm (l/min)	NOISE LEVEL dB	NET WEIGHT (kg)	SERVICE KIT	BOX/CTN
	Steel	Aluminium										
78-405	1.2	1.6	10,000	-	265	1/4	3/8	2 (57)	88	0.62	N.A.	1/2



10-Piece Sanding Disks Kit

- 10 piece 6" Sanding Disks Kit (220, 180, 80 Grits) – DA Sander

SKU#	DESCRIPTION	BOX/CTN
78-309	10-Piece Sanding Disks Kit	3/12

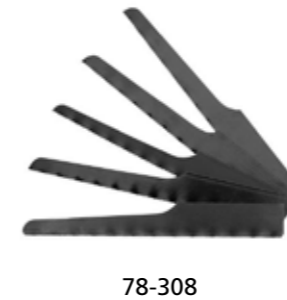

5-Piece Saw Blades Set

- 5 pieces of saw blades
- 32 teeth per inch-recip. saw

SKU#	DESCRIPTION	BOX/CTN
78-308	5-Piece Saw Blades Set	3/12



5-Piece Grinding Stone Set

- Fits rotary tools with 1/4 in. collets - 22,000 Max. RPM 2.
- Includes 5 of the most frequently used grinding wheels for air powered grinders (4 - 60 Grit, 1 - 45 Grit)

SKU#	DESCRIPTION	WEIGHT (g)	BOX/CTN
97-127	5-Piece Grinding Stone Set	227	3/12

Lever Action Grease Gun



78-031

- Precision-fitted and hardened plunger prevents lubricant escape from cartridge
- Extra-long handle for increased leverage and easy operation
- Rugged cast pump head for strength and durability and tough impact resistant construction
- Uses standard grease cartridge or can be used for bulk fill
- Heavy-duty
- Easy to operate
- Non-slip grip handle
- 12000PSI pressure
- High volume operation

SKU#	DESCRIPTION	VOLUME		LENGTH		BOX / CTN
		oz	gr	inch	mm	
78-031	Lever Action Grease Gun	14	400	6	150	6/24

Tire Inflator With Hose



95-710

- Ideal for garage
- Clip design at the end hands free
- Built-in Relief Valve
- 1/4" NPT inlet
- Comes with 25ft air hose, combined inflation gun, chuck and gauge

SKU#	DESCRIPTION	BOX / CTN
95-710	Tire inflator with hose	5/20

20 Piece Accessory Kit



97-124

- For use with air compressors
- 1/4 in. x 25 ft. Coil Air Hose - Max 200 PSI
- Blow Gun
- Dual-Head Tire Chuck
- Tire Gauge
- 1/4 in. Male Connector
- Blow Gun Nozzle 8. Blow Gun Adaptor
- Blow Gun Safety Nozzle 10 2-1/4 in. Female Quick-Connect coupler
- 1/4 in. Female Connector
- 2-1/4 in Female Quick-connect Plug
- 2-1/4 in. Male Quick-connect Plug
- Inflation needles
- Blow Gun Tapered Nozzle 16 Threaded Seal Tape

SKU#	DESCRIPTION	WEIGHT (g)	BOX/CTN
97-124	20 Piece Accessory Kit	907	1/3

Snap Ring Pliers (Internal And External)



89-479

- Cushion grip handles
- Interchangeable design for either internal or external use

SKU#	DESCRIPTION	OVERALL LENGTH	
		inch	BOX/CTN
89-479	Snap Ring Pliers – 5 1/2" Bent Jaws	5 1/2	12/120
89-480	Snap Ring Pliers – 5 1/2" Bent Jaws	7 1/2	12/120

Lock-Ring Pliers



89-481

- Spreads piston rings
- Spreads snap-lock rings found on brakes, transmission, pedal shifts, and machine tools
- O / A Length : 9", 229mm

SKU#	DESCRIPTION	WEIGHT (g)	BOX/CTN
89-481	Lock-Ring Pliers	254	12/48

1-1/2" Lock-Ring Pliers



89-482

- Straight tip design for spreading snap-lock rings
- Jaw opening : 1 1/2" (38.1mm)
- O / A Length : 9", 229mm

SKU#	DESCRIPTION	WEIGHT (g)	BOX/CTN
89-482	1-1/2" Lock-Ring Pliers	254	12/48

All-Brass Hammer



89-483

- Brass head
- Handle can be used for light striking applications

SKU#	CONTENTS	BOX QUANTITY
89-483	850g and 198mm(L) All-Brass Hammer	12
89-484	1450g and 222mm(L) All-Brass Hammer	24



82-100

Reversible 3-Jaw Puller

- Can be used with two or three jaws
- Ideal for industrial and automotive use
- Length: 4"
- Designed for heavy pulling jobs
- Chrome-vanadium steel
- Heat-treated
- Reversible jaws for external or internal pulling
- Flexible
- Heavy-duty

SKU#	DESCRIPTION	LENGTH		BOX/CTN
		inch	mm	
82-100	4" (100mm) 3-Jaw Puller plus 1 extra yoke	4	100	6/12

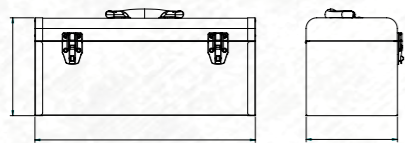

93-544

General Purpose Tool Box

- Overall dimension 430 x 178 x 191mm (W x D x H)
- ElectroPowder Coating to resist scratch and solvent markings
- Heavy-duty metal for body construction and handle to provide ultimate durability
- Double latch for greater strength
- Removable steel tray

SKU#	DESCRIPTION	BOX/CTN
93-544	General Purpose Tool Box	1/1

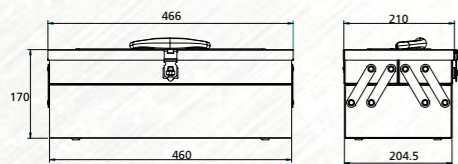

94-192

3-Tray Cantilever Box

- Overall dimension 466 x 210 x 170mm (W x D x H)
- Electro-Powder Coating to resist scratch and solvent markings
- Heavy-duty metal for body construction and handle to provide Ultimate durability
- Single latch for greater strength
- Tray swing out for easy tool access

SKU#	DESCRIPTION	BOX/CTN
94-192	3 Tray Cantilever Box	1/1

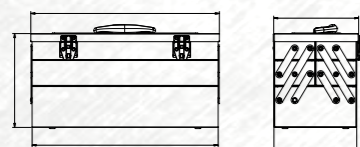

93-545

5-Tray Cantilever Box

- Overall dimension 466 X 204.5 X 232mm (W x D x H)
- Electro-Powder coating to resist scratch and solvent markings
- Double latch for greater strength
- Tray swing out for easy tool access

SKU#	DESCRIPTION	BOX/CTN
93-545	5 Tray Cantilever Box	1/1



95-890

3 Drawers Roller Cabinet

- 3 Drawers roller cabinet
- Overall dimension 600 x 400 x 900mm (W x D x H)
- Drawer Dimension 490 x 385 x 80mm (W x D x H)
- Comes with left side tray and left holder tray
- Lockable wheel with Rubber Castor
- Exchangeable handle (left or right)
- Bumper rubber on corners to prevent scratching
- Load capacity of top tray is 25kg, every drawer is 12kg, and bottom is 20kg

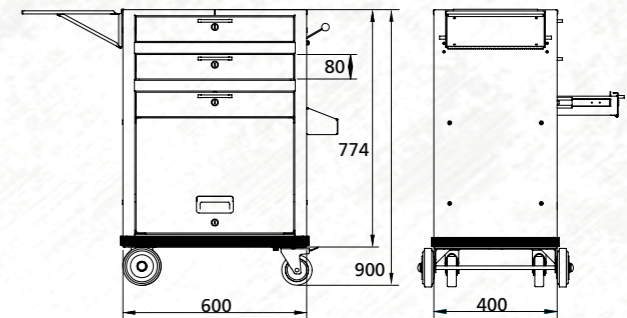

SKU#	DESCRIPTION	BOX/CTN
95-890	3 Drawers Roller Cabinet	1/1



99-069

4 Drawers Roller Cabinet

- Overall dimension 698 x 477 x 973mm (W x D x H)
- Drawer dimension 560 x 410 x 75.5mm (W x D x H)
- Load capacity of top tray is 30kg, every drawer is 25kg, and bottom is 35kg
- Plastic top tray to organise tools
- Comes with folding tray
- Lockable wheel with Rubber Castor
- Concave on both side to hold more tools
- Bumper rubber on corners to prevent scratching

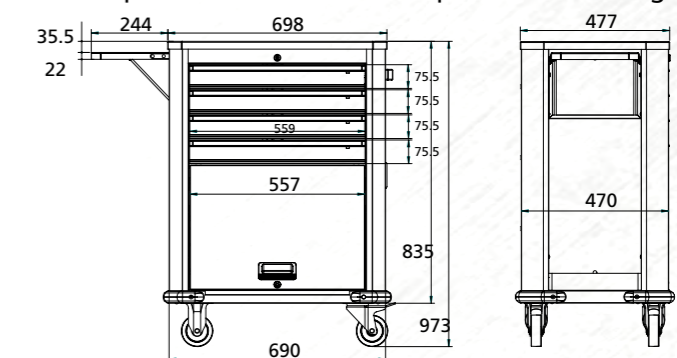

SKU#	DESCRIPTION	BOX/CTN
99-069	4 Drawers Roller Cabinet	1/1

7 Drawers Roller Cabinet



93-547

- Electro-Powder Coating to resist scratch & solvent markings
- Overall dimension 680 x 458 x 855.5mm (W x D x H)
- Ball bearing slide with quick disconnect
- Double wall construction with heavy-duty metal side handle to provide ultimate durability
- Full-length drawer pulls with liners included
- Heavy-duty 5" x 2" casters and easy grip cabinet side handle for better mobility

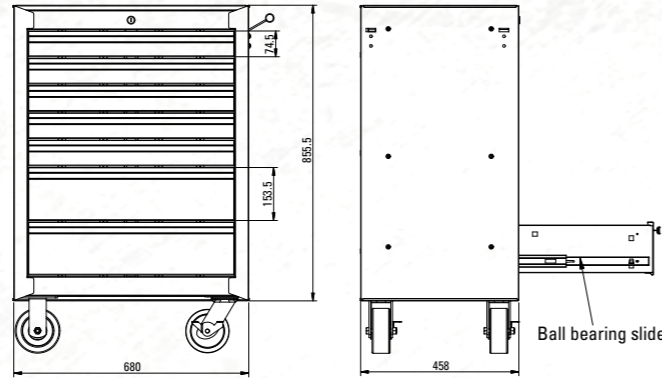

SKU#	DESCRIPTION	BOX/CTN
93-547	7 Drawers Roller Cabinet	1/1

*Notebook as image above is for illustration only

6 Drawer Top Chest



93-546

- Overall dimension 660 x 306 x 378mm (W x D x H)
- Electro-Powder Coating to resist scratch and solvent markings
- Ball bearing slide with quick disconnect
- Double wall construction with heavy-duty metal side handle to provide ultimate durability
- Full-length drawer pulls with liners included

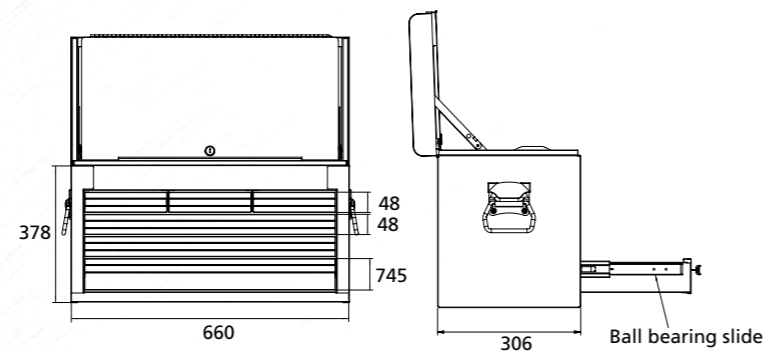

SKU#	DESCRIPTION	BOX/CTN
93-546	6 Drawer Top Chest	1/1

11 Piece 3/8" Drive Tune Up Kit Set

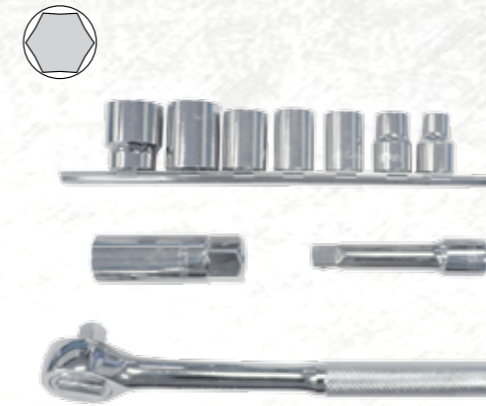

95-107

- Made with CR-V material with mirror finish
- Perfect tool for automotive and motorcycle maintenance
- Ideal for motorcycle repair shops and small machine repairs
- Sockets come with a clip rail for easy tool management

METRIC

- 7 pcs 3/8" dr 6 pt sockets : 8, 10, 11, 12, 13, 17, 19mm
- 3 pcs 3/8" dr accessories: 1 Spark plug socket: 16mm, 1 Spark plug socket: 14mm, 1 Extension bar: 3"
- 1 pc 3/8" dr Round head ratchet

SKU#	DESCRIPTION	BOX/CTN
95-107	11 Piece 3/8" Drive Tune Up Kit Set	1/24

9 Piece 1/2" Drive Torx® Bit Socket Set



89-098

- Drop-forged, heat-treated chrome vanadium steel
- Corrosion-resistant finish
- Also Fits Standard Torx® Sizes: T and TS
- Perfect use for temper-proof star fasteners in today's cars, trucks and appliances
- Precision-machined tip for exact fit

METRIC

- 9 pcs 1/2" dr Torx® bit socket set: t20, t25, t27, t30, t40, t45, t50, t55 & t60

SKU#	DESCRIPTION	WEIGHT (kg)	BOX/CTN
89-098	9 Piece 1/2" Drive Torx® Bit Socket Set	0.9	1/12

7-Piece 1/2" Drive Hex Bit Socket Set



89-099-1

- Perfect use for temper-proof star fasteners in today's automotive vehicles and appliances
- Drop-forged, heat-treated chrome vanadium steel
- Corrosion-resistant finish
- Perfect use for temper-proof star fasteners in today's cars, trucks and appliances
- Precision-machined tip for exact fit

METRIC

- 7 pcs 1/2" dr Hex bit socket set : 6, 8, 10, 12, 14, 17, 19mm
- 1 Blow-mold case

SKU#	DESCRIPTION	WEIGHT (g)	BOX/CTN
89-099-1	7 Piece 1/2" Drive Hex Bit Socket Set	1200	1/12



86-117

16-Piece 1/4" Drive Socket Set

METRIC

- 11 pcs 1/4" dr 6 pt sockets : 4, 5, 5.5, 6, 7, 8, 9, 10, 11, 12, 13mm
- 4 pcs 1/4" dr accessories : 3" & 6" Extension bar, 1/4" ratchet, 1 Universal joint, 1 Sliding T-bar
- 1 pc 1/4" Flip drive ratchet

SKU#	DESCRIPTION	WEIGHT (kg)	BOX/CTN
86-117	16-Piece 1/4" Drive Socket Set	0.98	1/12

21-Piece 1/4" Drive Socket Set

METRIC

- 8 pcs 1/4" dr 6 pt sockets : 5, 6, 7, 8, 10, 11, 12, 13mm

INCH

- 8 pcs 1/4" dr 6 pt sockets : 3/16, 7/32, 1/4, 9/32, 5/16, 3/8, 7/16, 1/2"
- 4 pcs 1/4" dr accessories : 2 Extension bar: 2" & 6", 1 Universal joint, 1 Spinner handle

SKU#	DESCRIPTION	WEIGHT (kg)	BOX/CTN
89-507	21-Piece 1/4" Drive Socket Set	4.58	4/4

35-Piece 1/4" Drive Socket Set

METRIC

- 13 pcs 1/4" dr 6 pt sockets : 4, 4.5, 5, 5.5, 6, 7, 8, 9, 10, 11, 12, 13, 14mm
- 5 pcs 1/4" dr accessories : 1 Spinner handle, 2 Extensions: 75, 150mm, 1 Universal joint, 1 Hex bit holder
- 4 Hex bits : 3, 4, 5, 6mm, 6 Torx® bits : T10, 15, 20, 25, 30, 40
- 3 Posidriv bits : 1, 2, 3, and 3 Slotted bits: 4, 5.5, 6.5mm
- 1 pc Quick release ratchet pear head
- 1 Blow-mould case

SKU#	DESCRIPTION	WEIGHT (kg)	BOX/CTN
89-033	35-Piece 1/4" Drive Socket Set	1.2	1/16



89-033-1

37-Piece 1/4" & 3/8" Drive Socket Set

METRIC

- 9 pcs 1/4" dr 6 pt sockets : 4, 5, 6, 7, 8, 9, 10, 11, 12mm
- 9 pcs 3/8" dr 12 pt sockets : 8, 10, 11, 12, 13, 14, 16, 17, 19mm

INCH

- 9 pcs 1/4" dr 6 pt sockets : 3/16, 7/32, 1/4, 9/32, 5/16, 11/32, 3/8, 7/16, 1/2"
- 7 pcs 3/8" dr 12 pt sockets : 3/8, 7/16, 1/2, 9/16, 5/8, 11/16, 3/4"
- 2 pcs 3/8" dr accessories : 1 Adapter, 1 1/4" dr spinner handle
- 1 "Full Polish" Quick release ratchet
- 1 Metal box

SKU#	DESCRIPTION	WEIGHT (kg)	BOX/CTN
89-518	37-Piece 1/4" & 3/8" Drive Socket Set	5.14	2/2



89-518

10-Piece 3/8" Drive Socket Set

INCH

- 7 pcs 3/8" dr 6 pt sockets : 3/8, 7/16, 1/2, 9/16, 5/8, 11/16 & 3/4"
- 1 pc 3/8" dr accessories : 1 Extension bar: 3"
- 1 pc 3/8" dr ratchet

SKU#	DESCRIPTION	WEIGHT (kg)	BOX/CTN
86-219	10-Piece 3/8" Drive Socket Set	0.85	4/24



86-219

24-Piece 3/8" Drive Socket Set

METRIC

- 19 pcs 3/8" dr 6 pt sockets : 6, 7, 8, 9, 10, 11, 12, 13, 14, 15, 16, 17, 18, 19, 20, 21, 22, 23, 24mm
- 4 pcs 3/8" dr accessories : 2 Extensions: 75, 150mm, 1 Universal joint, 1 Sliding T-bar
- 1 pc 3/8" Quick release ratchet pear head
- 1 Blow-mold case

SKU#	DESCRIPTION	WEIGHT (kg)	BOX/CTN
89-035-1	24-Piece 3/8" Drive Socket Set	3	1/8



89-035-1

48-Piece 3/8" Drive Socket Set

METRIC

- 12 pcs 3/8" dr 12 pt sockets :
8, 9, 10, 11, 12, 13, 14, 15, 16, 17, 18, 19mm

INCH

- 7 pcs 3/8" dr 12 pt sockets :
3/8, 7/16, 1/2, 9/16, 5/8, 11/16, 3/4"
- 18 pcs 1/4" dr Bit set :
6 Hex bits: 3, 4, 5, 6, 7, 8mm, 6 Torx® bits: T10, 15, 20, 25, 30, 40,
3 Posidriv bits: 1, 2, 3, and 3 Slotted bits: 4, 5, 6.5mm
- 8 pcs 3/8" dr accessories:
2 Spark plug 6pt socket: 5/8" & 13/16", 2 Extension bar: 3" & 6",
1 Universal joint, 1 Adapter, 1 1/4" dr spinner handle,
1 1/4" dr bit adapter
- 1 pc "Full Polish" Quick release ratchet
- 1 Metal box



89-516-1

SKU#	DESCRIPTION	WEIGHT (kg)	BOX/CTN
89-516-1	48-Piece 3/8" Drive Socket Set	6.12	2/2

11-Piece 1/2" Drive Socket Set

METRIC

- 10 pcs 1/2" dr 12 pt sockets:
10, 11, 12, 13, 14, 15, 16, 17, 18 & 19mm
- 1 pc 1/2" dr ratchet



86-734

SKU#	DESCRIPTION	BOX/CTN
86-734	11-Piece 1/2" Drive Socket Set	3/12

13-Piece 1/2" Drive Socket Set

METRIC

- 10 pcs 1/2" dr 12 pt sockets:
10, 11, 12, 13, 14, 16, 17, 19, 21, 22mm
- 2 pcs 1/2" dr accessories:
1 Extension bar: 5", 1 Sliding T bar
- 1 pc 1/2" Flip drive ratchet



86-501

SKU#	DESCRIPTION	BOX/CTN
86-501	13-Piece 1/2" Drive Socket Set	1/6

16-Piece 1/2" Drive Socket Set

METRIC

- 13 pcs 1/2" dr 12 pt sockets :
8, 10, 11, 12, 13, 14, 16, 17, 18, 19, 21, 22, 24mm
- 2 pcs 1/2" dr accessories :
125mm Extension bar, Universal joint
- 1 pc 1/2" Quick release ratchet pear head
- 1 Blow-mould case



89-092-1

SKU#	DESCRIPTION	WEIGHT (kg)	BOX/CTN
89-092-1	16-Piece 1/2" Drive Socket Set	3	1/6

22-Piece 1/2" Drive Socket Set

METRIC

- 17 pcs 1/2" dr 12 pt sockets :
12, 13, 14, 15, 16, 17, 18, 19, 20, 21, 22, 23, 24, 26, 27, 28,
30mm
- 4 pcs 1/2" dr accessories :
5" Extension bar, 10" Extension bar, Sliding T bar, Universal joint
- 1 pc 1/2" dr ratchet



86-531

SKU#	DESCRIPTION	BOX/CTN
86-531	22-Piece 1/2" Drive Socket Set	1/4

25-Piece 1/2" Drive Socket Set

METRIC

- 17 pcs 1/2" dr 6 pt sockets :
10, 11, 12, 13, 14, 15, 17, 18, 19, 20, 21, 22, 23, 24, 27, 30,
32mm
- 6 pcs 1/2" dr accessories:
1 Spark plug socket, 1 Sliding T-Bar: 10",
1 Universal joint, 1 Flex handle: 17", 2 Extension bar: 5" & 10"
- 1 pc "Fully polished" Quick release ratchet
- 1 Blow-mold case



86-589-1

SKU#	DESCRIPTION	WEIGHT (kg)	BOX/CTN
86-589-1	25-Piece 1/2" Drive Socket Set	5.8	1/4

27-Piece 1/2" Drive Socket Set



86-478-1

INCH

- 20 pcs 1/2" dr 12 pt sockets :
1/4, 5/16, 3/8, 7/16, 1/2, 9/16, 19/32, 5/8, 11/16, 3/4,
25/32, 13/16, 7/8, 15/16, 31/32, 1, 1-1/16, 1-1/8, 1-3/16, 1-1/4"
- 5 pcs 1/2" dr accessories :
2 Extension bar: 5" & 10", 1 Universal joint,
1 Spark plug socket 6 pt 13/16", 1 Sliding T-Bar: 9.5"
- 1 pc Flip-drive ratchet
- 1 Blow-mold case

SKU#	DESCRIPTION	WEIGHT (kg)	BOX/CTN
86-478-1	27-Piece 1/2" Drive Socket Set	4.59	4/4

27-Piece 1/2" Drive Socket Set



86-477

METRIC

- 20 pcs 1/2" dr 12 pt sockets :
10, 11, 12, 13, 14, 15, 16, 17, 18, 19, 20, 21, 22, 23, 24, 25, 26, 27,
30, 32mm
- 5 pcs 1/2" dr accessories :
2 Extension bar: 5" & 10", 1 Universal joint,
1 Spark plug socket 6pt 13/16", 1 sliding T-Bar: 9.5"
- 1 pc Flip-drive ratchet
- 1 Blow-mold case

SKU#	DESCRIPTION	WEIGHT (kg)	BOX/CTN
86-477	27-Piece 1/2" Drive Socket Set	4.55	1/4

29-Piece 1/2" Drive Socket Set



86-504

METRIC

- 21 pcs 1/2" dr 12 pt sockets :
10, 11, 12, 13, 14, 15, 16, 17, 18, 19, 20, 21, 22, 23, 24, 25, 26, 27,
28, 30, 32mm
- 4 pcs 1/2" dr accessories :
2 Extensions: 5" & 10", 1 adapter, 1 handle
- 1 pc Flip-drive ratchet

SKU#	DESCRIPTION	BOX/CTN
86-504	29-Piece 1/2" Drive Socket Set	1/3

43-Piece 1/2" Drive Socket Set



89-509

METRIC

- 20 pcs 1/2" dr 12 pt sockets :
10, 11, 12, 13, 14, 15, 16, 17, 18, 19, 20, 21, 22, 23, 24, 26, 27, 28,
30, 32mm

INCH

- 15 pcs 1/2" dr 12 pt sockets :
3/16, 7/16, 1/2, 9/16, 5/8, 11/16, 3/4, 13/16, 7/8, 15/16, 1, 1-1/16,
1-1/8, 1-3/16, 1 1/4"
- 7 pcs 1/2" dr accessories :
2 Spark plug 6pt socket: 5/8" & 13/16",
3 Extension bar: 3", 5" & 10", 1 Universal joint,
1 Flex handle: 375mm
- 1 pc "Full Polish" Quick release ratchet
- 1 Metal box

SKU#	DESCRIPTION	WEIGHT (kg)	BOX/CTN
89-509	43-Piece 1/2" Drive Socket Set	7.86	2/2

15-Piece 3/4" Drive Socket Set



91-943-1

METRIC

- 10 pcs 3/4" dr 12 pt sockets :
30, 32, 34, 36, 38, 41, 46, 50, 55, 60mm
- 4 pcs 3/4" dr accessories :
2 Extension bar: 4" & 8", 1 Universal joint, 1 Sliding joint
- 1 pc Professional ratchet
- 1 Metal box

SKU#	DESCRIPTION	WEIGHT (kg)	BOX/CTN
91-943-1	15-Piece 3/4" Drive Socket Set	13.7	1/1

19-Piece 3/4" Drive Socket Set



89-101-1

METRIC

- 15 pcs 3/4" dr 12 pt sockets :
22, 24, 27, 28, 29, 30, 32, 33, 34, 36, 38, 41, 42, 46, 50mm
- 3 pcs 3/4" dr accessories :
2 Extension 100 & 200mm, 1 Sliding T-bar 250mm
- 1 pc Standard ratchet
- 1 Blow-mold case

SKU#	DESCRIPTION	WEIGHT (kg)	BOX/CTN
89-101-1	19-Piece 3/4" Drive Socket Set	13	1/1



89-133-1

19-Piece 3/4" Drive Socket Set

INCH

- 15 pcs 3/4" dr 12 pt sockets :
7/8, 15/16, 1, 1 1/6, 1 1/8, 1 3/16, 1 1/4, 1 5/16, 1 3/8, 1 13/16, 1 11/16, 1 5/8, 1 1/2, 1 7/8, 2"
- 3 pcs 3/4" dr accessories :
2 Extensions: 100 & 200mm, 1 Sliding T-Bar: 250mm
- 1 pc standard ratchet
- 1 Blow-mold case

SKU#	DESCRIPTION	WEIGHT (kg)	BOX/CTN
89-133-1	19-Piece 3/4" Drive Socket Set	13.4	1/2

5-Piece Screwdriver Bit Socket Clip Rail - 3/8" Drive

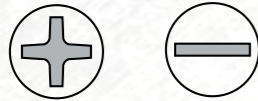

87-344

- A comprehensive set of the most common Standard and Phillips® bit sizes
Allows for the tightening and removal of standard and Phillips® screws with a 3/8" ratchet

INCH

- 5 pcs 3/8" dr Screwdriver bit socket clip rail:
⊕ : #1, #2, #3 ⊖ : 1/4 & 9/32

SKU#	DESCRIPTION	BOX/CTN
87-344	5 Piece Screwdriver Bit Socket Clip Rail - 3/8" Drive	3/12

5-Piece Hex Bit Socket Clip Rail - 3/8" Drive



87-343

- A comprehensive set of the most common Standard and Phillips® bit sizes
Allows for the tightening and removal of Hex screws with a 3/8" ratchet

INCH

- 5 pcs 3/8" dr Hex bit socket clip rail :
3/16, 7/32, 1/4, 5/16 & 3/8

SKU#	DESCRIPTION	BOX/CTN
87-343	5 Piece Hex Bit Socket Clip Rail - 3/8" Drive	3/12

7-Piece Torx® Socket Clip Rail - 3/8" Drive



87-342

- A comprehensive set of the most common Torx® bit sizes
Allows for the tightening and removal of Torx® screws with a 3/8" ratchet

INCH

- 7 pcs 3/8" dr Torx® socket clip rail :
t15, t20, t25, t30, t40, t45 & t50

SKU#	DESCRIPTION	BOX/CTN
87-342	7 Piece Torx® Socket Clip Rail - 3/8" Drive	6/12

161- Piece 1/2" Drive Socket Merchandizer Set

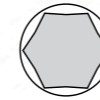

89-001A

METRIC

- 12 pcs 1/2" dr 6pt std sockets :
8, 10, 11, 12, 13, 14, 15, 17, 18, 19mm
- 8 pcs 1/2" dr 6pt std sockets :
21, 22, 24, 27mm
- 4 pcs 1/2" dr 6pt std sockets :
30, 32mm
- 1 pc 1/2" dr Socket Merchandizer

SKU#	DESCRIPTION	BOX/CTN
89-001A	161 Piece 1/2" Drive Socket Merchandizer Set	1/1

167- Piece 1/2" Drive Socket Merchandizer Set

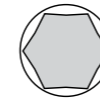

89-001

METRIC

- 12 pcs 1/2" dr 6pt std sockets :
8, 10, 11, 12, 13, 14, 15, 17, 18, 19mm
- 8 pcs 1/2" dr 6pt std sockets :
21, 22, 24, 27mm
- 4 pcs 1/2" dr 6pt std sockets :
30, 32mm
- 6pcs 1/2" dr 6pt std socket:
16mm
- 1 pc 1/2" dr Socket Merchandizer

SKU#	DESCRIPTION	BOX/CTN
89-001	167 Piece 1/2" Drive Socket Merchandizer Set	1/1

1/2" Drive Socket Set Merchandizer

- Plastic casing only

SKU#	DESCRIPTION	BOX/CTN
89-001MB	1/2" Drive Socket Set Merchandizer	1/1



89-001MB

9 TOOLS STORAGE

PROFESSIONAL DESIGN, VERSATILITY & DURABILITY

Quality, innovation and durability – the same principles used to build world-class hand tools is applied to the manufacture of our tools storage products. This comprehensive category is divided into 6 product lines: tool bags, toolboxes, mobile storage devices, organizers and bins, garage workshop cabinets, and collapsible sawhorses. In total, there are more than 80 storage products available, and each one is well-engineered, thoughtfully designed and job-site tough.



ZAG® MODULAR ROLLING WORKSHOP W/ONE TOUCH LATCH TOOLBOX + DRAWER



- Portable detachable containers with handles on top allows for the customization of storage options and to carry only the options you need.
- Top detachable toolbox with drawer and one hand operation latch, 2 drawer storage unit with shallow & deep drawer and bottom flip bin with back pocket for long tools storage (saw & level) - versatile organization for various sizes of tools and small parts.
- Aluminum telescopic back handle for easy elevation; handle can be lowered for storage.
- Heavy-duty ball bearing slides for the drawers-quality drawer sliding system with better grip and locking mechanism.
- Heavy-duty 7" wheels for easy on-site maneuverability.
- On top 19" toolbox with one hand operation latch allowing to open the box when the other hand is occupied.

We understand that transporting the right tools and components quickly and easily to the jobsite is an issue for every pro, so having examined the needs of different trades we've created our Modular Rolling Workshop. The 7" full rubber wheels are designed for tough terrains, it has a large flip bin for power tools, a two drawer organizer unit and a toolbox with a further organizer drawer. Each unit can be easily separated and carried individually, or two can be carried together, connected by the heavy-duty side latches.



MOBILE WORK CENTER™ 2 IN 1 WITH SOFT FRONT POCKET + 12.5" SERIES 2000 WITH 2 BUILT-IN ORGANIZERS WITHOUT TRAY

Mobile Work Center (18600) + 13" Tool Box

Mobile Work Center 2-in-1 with Soft Front Pocket

- 2-in-1 = separates in seconds into an extra large box and giant bin
- Small parts storage with swivel front drawer (carousel) and front fabric organizer with bungee cord
- Smooth mobility - large "truck" wheels
- Easy to operate with an aluminum telescopic pull handle
- Load capacity 40KG
- Conveniently fits into a car

12.5" Series 2000 with Built-In Organizers w/o tray

- 2 top organizers for small parts storage – accessible without opening the tool box
- Pad lock eye
- Tote tray

SKU#	DESCRIPTION	ITEM SIZE	BOX/CTN
60729	Mobile Work Center (18600) + 13" Tool Box	47 x 29.8 x 61.9 cm 18-1/2" x 11-13/16" x 24-3/8"	1/4



STANLEY® 2-in-1 Mobile Work Center

- 2 storage solutions in one includes extra large toolbox, storage bin
- Large, heavy-duty nickel-plated metal latches
- Two transparent lid organizers and middle carousel offer extensive small parts storage
- Front pocket for storage of extension cord, other cables
- Large truck wheels enable smooth, easy mobility
- Conveniently fits into car trunk or back seat

SKU#	DESCRIPTION	ITEM SIZE	BOX/CTN
18603	STANLEY® 2-in-1 Mobile Work Center	25" x 19" x 12" (635mm x 482.6mm x 304.8mm)	2/2



18603

STANLEY® Pro Mobile Tool Chest

The STANLEY® Pro Mobile Tool Chest with durable plastic outer meets all your storage solutions in a handy portable form. With removable compartments for small parts and soft grip handle for comfort when carrying

SKU#	DESCRIPTION	ITEM SIZE	BOX/CTN
97-503	STANLEY® Pro Mobile Tool Chest	24" x 16.5" x 14" (620mm x 419mm x 375mm)	1/1



97-503

Mobile Tool Chest with 2 Built-in Organizers, 2 Trays & Pull Handle



92-703

SKU#	DESCRIPTION	ITEM SIZE	CARTON LOADING	CARTON SIZE	CARTON WEIGHT	BOX/CTN
92-703	Mobile Tool Chest w/ 2 Organizers, 2 Trays & Pull Handle	56.2 x 31.4 x 28.3 cm 22-1/8" x 12-3/8" x 11-1/8"	2	62.8 x 38.8 x 85.8 cm 24-11/6" x 15-5/16" x 33-13/16"	7.5 kg 16.5 lbs	2/2

20" Metal Rolling Workshop



20580

SKU#	CARTON SIZE	CARTON WEIGHT	40ft HICUBE	40ft CONT.	20ft CONT.	ITEM SIZE	BOX/CTN
20580	22-2/5x 16-1/8x28-7/8 in 57.0x41.0x73.5cm	25.33lb 11.5kg	403	339	159	22-2/5x5-7/8x11-2/5" 56.8x38.9x73 cm	1/1

Metal Plastic Rolling Tool Chest (Yellow)



60929

SKU#	CARTON SIZE	CARTON WEIGHT	40ft HICUBE	40ft CONT.	20ft CONT.	ITEM SIZE	BOX/CTN
60929	25-7/8x15-3/4x25-1/2 in 65.8x39.9x64.8cm	24.22lb 11kg	404	357	169	25-2/3x15-2/5x25-1/8" 65.0x39.0x64.0 cm	1/1

Metal Plastic Rolling Tool Chest (Yellow)



33280

SKU#	CARTON SIZE	CARTON WEIGHT	40ft HICUBE	40ft CONT.	20ft CONT.	ITEM SIZE	BOX/CTN
33280	25-7/8x15-3/4x17-1/8 in 65.8x39.9x43.5cm	15.92lb 7.23kg	622	505	240	25-2/3x15-2/5x16-7/8" 65.0x39.0x43.0 cm	1/1

All Project Vehicle

- Innovative design - eye catcher
- 2-in-1 = Easily separates into 2 units
- Bottom bin and top part which can be carried like a tool box
- Wide heavy-duty wheels
- Durable pull handle - comfortable grip

SKU#	DESCRIPTION	BOX/CTN
18700	All Project Vehicle	2/2



18700

Open Mouth Wheeled Tool Bag – 20"



93-328

- Made of durable, tough wear and water-resistant plastic wrapped in and virtually maintenance-free 600 denier polyester fabric
- Integrated foam rubber and plastic structure reinforcements create a non-collapsing design
- Elevated feet
- Open mouth design with zipper allows for easy access/secure transport of bag contents
- Heavy-duty metal framework supports open mouth design
- Large handles for comfort and grip with padded over wrap to fasten both handles together
- Telescoping handle extends to a height of 39" for easy tool transport
- Two (2) 1.5" wide casters bracket mounted with heavy-duty metal rivets

SKU#	DESCRIPTION	ITEM SIZE	MAIN STORAGE	BOX/CTN
93-328	Open Mouth Wheeled Tool Bag – 20"	19" x 9" x 12" 50mm x 23mm x 30mm	2,052 inch ³	1/2

20" Metal Plastic Tool Box (Yellow)



20080

SKU#	CARTON SIZE	CARTON WEIGHT	40ft HICUBE	40ft CONT.	20ft CONT.	ITEM SIZE	BOX/CTN
20080	20X11-4/5X35-3/5in 50.8x30.3x89.3 cm	23.1 lb 10.5 kg	1,968	1,812	880	19-1/2x11-1/2x5-5/8" 49.7x29.3x22.2 cm	1/1

20" Professional Tool Box



20300

SKU#	CARTON SIZE	CARTON WEIGHT	40ft HICUBE	40ft CONT.	20ft CONT.	ITEM SIZE	BOX/CTN
20300	22-1/2X21X31-7/8in 57.2x53.3x81.1 cm	37.1 lb 17.1 kg	1,584	1,404	702	19-7/8x10-7/8x10-5/8" 50.5x27.6x26.9 cm	6/6

26" Professional Tool Box



26300

SKU#	CARTON SIZE	CARTON WEIGHT	40ft HICUBE	40ft CONT.	20ft CONT.	ITEM SIZE	BOX/CTN
26300	26-3/4x22-1/2x31-15/16in 67.9x57.2x81.1 cm	46.5 lb 21.1 kg	1,224	1,614	551	25-1/2x10-3/4x10-1/2" 65.1x27.6x26.9 cm	6/6

JUMBO TOOL BOX WITH 2 PULL OUT ORGANIZERS, BIT HOLDER AND METAL LATCHES

Combo 19028 + 13013



60-886

- Organizers, accessible without opening the box
- 2 organizers are removable and can be carried outside the toolbox
- Tote tray
- Padlock eye
- Soft wide rubber coated handle - easy grip
- Nickel-plated latches

12.5" Series 2000 with Built-in Organizers without tray

- With 12.5" tool box inside with top organizers for small parts storage
- Inclusive of tray inside

SKU#	DESCRIPTION	ITEM SIZE	BOX/CTN
60-886	Combo Jumbo Tool Box (19028 & 13013)	48.6 x 27.6 x 23.2 cm 19-1/8" x 10-7/8" x 9-1/8"	1/6

Jumbo 16" Tool Box With 2 Pull Out Organizers and Bit Holder



92-116

SKU#	DESCRIPTION	ITEM SIZE	CARTON LOADING	CARTON SIZE	CARTON WEIGHT	BOX/CTN
92-116	Jumbo 16" Tool Box w/2 Pull Out Organizers & Bit Holder	39.4 x 25.4 x 17.8 cm 15-1/2" x 10" x 7"	6	48.5 x 40.8 x 55.9 cm 19-1/8" x 16-1/8" x 22"	7.7 kg 17 lbs	6/6

Jumbo 19" Tool Box With 2 Pull Out Organizers and Bit Holder



92-120

SKU#	DESCRIPTION	ITEM SIZE	CARTON LOADING	CARTON SIZE	CARTON WEIGHT	BOX/CTN
92-120	Jumbo 19" Tool Box w/2 Pull Out Organizers & Bit Holder	48.6 x 27.6 x 23.2 cm 19-1/8" x 10-7/8" x 9-1/8"	6	48.5 x 40.8 x 55.9 cm 19-1/8" x 16-1/8" x 22"	11.7 kg 25.8 lbs	6/6



92-146

**Jumbo 22" Tool Box
With 2 Pull Out Organizers and Bit Holder**

SKU#	DESCRIPTION	ITEM SIZE	CARTON LOADING	CARTON SIZE	CARTON WEIGHT	BOX/CTN
92-146	Jumbo 22" Tool Box w/2 Pull Out Organizers & Bit Holder	56.2 x 31.4 x 28.3 cm 22-1/8" x 12-3/8" x 11-1/8"	3	88 x 56.5 x 29.5 cm 34-5/8" x 22-5/16" x 11-5/8"	7.5 kg 16.5 lbs	3/3



92-905

**Jumbo 16" Tool Box
With 2 Pull Out Organizers, Bit Holder and Metal Latches**

SKU#	DESCRIPTION	ITEM SIZE	CARTON LOADING	CARTON SIZE	CARTON WEIGHT	BOX/CTN
92-905	Jumbo 16" Tool Box with 2 Pull Out Organizers, Bit Holder & Metal Latches	39.4 x 25.4 x 17.8 cm 15-1/2" x 10" x 7"	6	53.5 x 49.5 x 72.5 cm 21-1/8" x 19-1/2" x 28-5/8"	7.7 kg 17 lbs	6/6



92-906

**Jumbo 19" Tool Box
With 2 Pull Out Organizers, Bit Holder and Metal Latches**

SKU#	DESCRIPTION	ITEM SIZE	CARTON LOADING	CARTON SIZE	CARTON WEIGHT	BOX/CTN
92-906	Jumbo 19" Tool Box with 2 Pull Out Organizers, Bit Holder & Metal Latches	48.6 x 27.6 x 23.2 cm 19-1/8" x 10-7/8" x 9-1/18"	6	53.5 x 49.5 x 72.5 cm 21-1/8" x 19-1/2" x 28-5/8"	11.7 kg 25.8 lbs	6/6



92-908

**Jumbo 22" Tool Box
With 2 Pull Out Organizers, Bit Holder and Metal Latches**

SKU#	DESCRIPTION	ITEM SIZE	CARTON LOADING	CARTON SIZE	CARTON WEIGHT	BOX/CTN
92-908	Jumbo 22" Tool Box with 2 Pull Out Organizers, Bit Holder & Metal Latches	56.2 x 31.4 x 28.3 cm 22-1/8" x 12-3/8" x 11-1/18"	3	88 x 56.5 x 29.5 cm 34-5/8" x 22-5/16" x 11-5/8"	7.5 kg 16.5 lbs	3/3



92-064

**12.5" Series 2000
With 2 Built-In Organizers & Tray, Metal Latch**

SKU#	CARTON SIZE	CARTON WEIGHT	40ft HICUBE	40ft CONT.	20ft CONT.	ITEMSIZE	BOX/CTN
92-064	19-11/16x 12-7/8x11 in 50x32.7x 28 cm	7.7 lb 3.5 kg	9,624	8,316	4,116	12-1/2x7x 5-1/8" 31.8x17.8x 13 cm	6/6



16011

**16" Series 2000
With 2 Built-In Organizers & Tray**

SKU#	CARTON SIZE	CARTON WEIGHT	40ft HICUBE	40ft CONT.	20ft CONT.	ITEMSIZE	BOX/CTN
16011	22-5/8 x 16-1/2 x 15 in 57.3 x 41.8 x 38.1 cm	16.5 Lb 7.5 Kg	4,746	4,194	1,950	15-7/8 x 8-1/8 x 7-1/8" 40.3 x 17.8 x 13 cm	6/6



15101

**15" Tool Box
With Built-In Organizer & Tray**

SKU#	CARTON SIZE	CARTON WEIGHT	40ft HICUBE	40ft CONT.	20ft CONT.	ITEM SIZE	BOX/CTN
15101	19-5/8x12-7/8x11 in 49.9x32.7x 28 cm	7.7 lb 3.5 kg	9,600	8,520	4,152	12-1/4x 7x5" 31.4x17.8x 12.7 cm	6/6



13011

**12.5" Series 2000
With 2 Built-In Organizers & Tray**

SKU#	CARTON SIZE	CARTON WEIGHT	40ft HICUBE	40ft CONT.	20ft CONT.	ITEM SIZE	BOX/CTN
13011	19-11/16x 12-7/8x11 in 50x32.7x 28 cm	7.7 lb 3.5 kg	9,624	8,346	4,116	12-1/2x7x 5-1/8" 31.8x17.8x 13 cm	6/6



19011

**19" Series 2000
With 2 Built-In Organizers & Tray**

SKU#	CARTON SIZE	CARTON WEIGHT	40ft HICUBE	40ft CONT.	20ft CONT.	ITEM SIZE	BOX/CTN
19011	23x14x27 in 72x50x51 cm	24.7 lb 11.7 kg	2,160	1,830	840	19-1/4x10-1/4x9-3/4" 46.9x26x 24.8 cm	6/6



92-764

Power Tool Case with Organizer

SKU#	CARTON SIZE	CARTON WEIGHT	40ft HICUBE	40ft CONT.	20ft CONT.	ITEM SIZE	BOX/CTN
92-764	29-1/8x15-1/2x22-7/8" 74x39.3x58.2 cm	23.5 lb 10.7 kg	2,412	2,256	1,056	14-7/8x 14-3/8x 7-5/16" 37.8x36.5x 18.4 cm	6/6



518160

FatMax® 18" Open Tote (Grey / Black)

SKU#	CARTON SIZE	CARTON WEIGHT	40ft HICUBE	40ft CONT.	20ft CONT.	ITEM SIZE	BOX/CTN
518160	20-5/8x19-7/16x27-3/8" 53x49.5x70.5 cm	22 lb 10 kg	1,300	1,020	485	18-7/8x9-7/8x13" 48x25x33 cm	4/4



516110

16" Multi Purpose Tool Bag (Black / Grey)

SKU#	CARTON SIZE	CARTON WEIGHT	40ft HICUBE	40ft CONT.	20ft CONT.	ITEM SIZE	BOX/CTN
516110	18-3/4x17-1/8x10-1/2" 47x43.6x26.7 cm	8.3 lb 3.7 kg	2,442	2,212	1,068	16-1/4x8-5/8x9-7/8" 41x22x25 cm	2/2



512100

12" Tool Bag (Grey / Black)

SKU#	CARTON SIZE	CARTON WEIGHT	40ft HICUBE	40ft CONT.	20ft CONT.	ITEM SIZE	BOX/CTN
512100	12-3/4x10-1/4x9" 32.6x26.1x23 cm	3.4 lb 1.548 kg	6,760	6,126	2,958	11-3/4x5x9-3/4" 30x13x25 cm	2/2



509100

9" Pouch (Black / Grey)

SKU#	CARTON SIZE	CARTON WEIGHT	40ft HICUBE	40ft CONT.	20ft CONT.	ITEM SIZE	BOX/CTN
509100	16-3/4x10-1/4x12-3/8" 42.5x26x31.3 cm	7.1 lb 3.2 kg	22,068	19,992	9,648	6-1/4x4-1/4x9-3/8" 16x11x24 cm	12/12



14325

25 Compartment Professional Organizer

SKU#	CARTON SIZE	CARTON WEIGHT	40ft HICUBE	40ft CONT.	20ft CONT.	ITEM SIZE	BOX/CTN
14325	26x17-5/16x13-1/2" 66x44x34.4 cm	35.3 lb 16 kg	2,634	2,350	1,104	16-1/4x17x4-1/3" 49.2x43.1x11 cm	12/12



14004

Organizer 160 14 Compartments Organizer

SKU#	CARTON SIZE	CARTON WEIGHT	40ft HICUBE	40ft CONT.	20ft CONT.	ITEM SIZE	BOX/CTN
14004	26-5/8x13-1/2x10-1/16" 67.5x34.4x27.1 cm	13.2 lb 6 kg	13,452	12,144	6,072	13-1/8x10x2-1/8" 33.23x25.4x5.4 cm	12/12



14209

9 Compartment Professional Organizer

SKU#	CARTON SIZE	CARTON WEIGHT	40ft HICUBE	40ft CONT.	20ft CONT.	ITEM SIZE	BOX/CTN
14209	21-3/16x17-3/16x27" 53.8x43.7x68.6 cm	55.1 lb 25 kg	17,320	13,800	6,720	8-1/4x13-1/8x2-1/4" 21.1x33.4x5.2 cm	40/40



14408 & 14408 New

8 Compartment Professional Organizer

SKU#	CARTON SIZE	CARTON WEIGHT	40ft HICUBE	40ft CONT.	20ft CONT.	ITEM SIZE	BOX/CTN
14408	26x17-5/16x13-1/2" 66x44x34.4 cm	24 lb 10.9 kg	4,482	2,930	1,860	16-9/16x13-1/8x4-1/8" 42.3x33.4x10.5 cm	6/6



60565

Organizer 33 (3 x 14003)

SKU#	CARTON SIZE	CARTON WEIGHT	40ft HICUBE	40ft CONT.	20ft CONT.	ITEM SIZE	BOX/CTN
60565	26-1/4x21x24-7/8" 41.4x53.5x63.4 cm	46.2 lb 21 kg	27,840	25,500	12,480	7-7/8x4x3-7/8" 20.1x10.3x10.1 cm	60/60



56208

Bonus Pack (8 Bin #2 + 3 Bin Hangers)

SKU#	CARTON SIZE	CARTON WEIGHT	40ft HICUBE	40ft CONT.	20ft CONT.	ITEM SIZE	BOX/CTN
56208	29-13/16x 22-3/4x 13-7/8"	36.7 lb 16.2 kg	9,261	7,938	3,906	4-1/4x7-1/2x 13-3/8" 10.8x19.1x 34 cm	21/21



56304

Bonus Pack (4 Bin #3 + 2 Bin Hangers)

SKU#	CARTON SIZE	CARTON WEIGHT	40ft HICUBE	40ft CONT.	20ft CONT.	ITEM SIZE	BOX/CTN
56304	30-3/16x 19-11/16x 25-13/16"	39.2 lb 17.8kg	5,520	4,200	2,040	5-3/4x9-3/8x 12-5/8" 14.6x23.8x 32.1 cm	20/20

25-Piece Do-it-all Tools Set



92-006

- 1 pc Wood Handle Nail Hammers 7oz
- 1 pc STANLEY Tape Rules 3meter 1
- 1 pc Knife
- 1 pc Metric Hex Key Set 10pcs
- 1 pc Linesman Pliers 8"
- 1 pc Long nose Pliers 6"
- 1 pc Adjustable wrench 8"
- 1 pc 6-way screwdriver
- 1 pc Digital Spark Test Pen
- 1 pc Torch Light
- 1 pc Waterproof Tools Bag

SKU#	DESCRIPTION	BOX/CTN
92-006	25 pcs Electrician's Tools Set	1/9



90-596N

7-Piece Tools Set

- 1pc Linesman Pliers : 7"
- 1pc Adjustable Wrench : 8"
- 1pc Cushion Grip : 6x100
- 1pc Cushion Grip : M6x100
- 1pc STANLEY Tape Rules : 3m
- 1pc Snap-Off Blade : 18mm
- 1pc Test Pen : 100-500V24

SKU#	DESCRIPTION	BOX/CTN
90-596N	7-pc Tools Set	1/36



92-003-2

6-Piece Slim Tools Set

- 1pc Slim Standard Screwdriver : 3 x 125mm
- 1pc Slim Standard Screwdriver : 3 x 150mm
- 1pc Slim Phillips Screwdriver : #0 x 125mm
- 1pc Slim Phillips Screwdriver : #0 x 125mm
- 1pc Slim Diagonal Cutting Pliers : 125mm
- 1pc Slim Long Nose Pliers : 100mm

SKU#	DESCRIPTION	BOX/CTN
92-003-2	6 pcs Slim Tools Set	6/24



90-597

18-Piece Tools Set

- 1pc Precision Screwdriver Set
- 1pc Linesman Pliers : 8"
- 1pc Long Nose Pliers : 6"
- 1pc Adjustable Wrench : 8"
- 1pc Test Pen 100-500V AC : 150mm
- 1pc Snap-Off Knife : 9mm
- 1pc Cushion Grip : 3 x 100mm
- 1pc Cushion Grip : #0 x 100mm
- 1pc Cushion Grip : 6.5 x 150mm
- 1pc Cushion Grip : #2 x 150mm
- 1pc Solder Iron : 30W/220W
- 1pc STANLEY Tape Rules : 8m
- 1pc Metric Hex Key Set : 10pcs
- 1pc Wood Handle Nail Hammers : 130Z
- 1pc Mini Hacksaw : 8-3/4"
- 1pc Torch Light
- 1pc Pinch
- 1pc Scissor
- 1pc Nylon Bag

SKU#	DESCRIPTION	BOX/CTN
90-597	18-pc Tools Set	1/5

19-Piece Home-Use Tools Set



92-009

- 1 pc STANLEY Tape Rules : 3m
- 1 pc 6-way Screwdriver
- 1 pc Linesman Pliers : 8"
- 1 pc Snap-Off Knife : 18mm
- 1 pc Adjustable Wrench : 8"
- 1 pc Mini Hacksaw : 8-3/4"
- 1 pc Precision Screwdriver Set
- 1 pc Wood Handle Nail Hammers : 13oz
- 1 pc Digital Spark Test Pen
- 1 pc Water Proof Tool Bag

SKU#	DESCRIPTION	BOX/CTN
92-009	19-pc Home-use Tools Set	1/5

22-Piece Must-Have Tools Set



92-010

- 1pc STANLEY Tape Rules : 5m
- 1pc Cushion Grip Screwdriver Phillips® : #1x100mm
- 1pc Cushion Grip Screwdriver Phillips® : #2x150mm
- 1pc Cushion Grip Screwdriver : 5x100mm
- 1pc Cushion Grip Screwdriver : 6.5x100mm
- 1pc Metric Hex Key Set : 10 pcs
- 1pc MaxGrip® Pliers Linesman : 8"
- 1pc MaxGrip® Pliers Long Nose : 6"
- 1pc Knife Snap Off Blade
- 1pc Adjustable Wrench : 8"
- 1pc Mini Hacksaw : 3/4"
- 1pc Hammer 16oz Claw
- 1pc Tool Bag

SKU#	DESCRIPTION	BOX/CTN
92-010	22-pc Must-have Tools Set	1/5



92-005

22-Piece Electrician's Tools Set

- 1pc STANLEY Tape Rules : 3m
- 1pc Multimeter
- 1pc Slip Joint Pliers : 8"
- 1pc Long Nose Pliers : 6"
- 1pc Metric Hex Key Set : 10pcs
- 1pc Adjustable Wrench : 6"
- 1pc Cushion Grip : #1 x 100mm
- 1pc Cushion Grip : 5 x 100mm
- 1pc Digital Spark Test Pen
- 1pc Torch Light
- 1pc PVC Adhesive Tape
- 1pc Electrician Knife
- 1pc Waterproof Tool Bag

SKU#	DESCRIPTION	BOX/CTN
92-005	22-pc Electrician's Tools Set	1/6

10 POWER CLEANING TOOLS

INDUSTRIAL, POWERFUL & PORTABLE

STANLEY® Power Cleaning Tools provide superior performance in any environment. From the portable 1400W Pressure Washer to 16 Gallons Stainless Steel Wet/Dry Vacuum Cleaner for heavy-duty use, STANLEY® cleaning tools makes even the toughest jobs easy, saving you time and effort. With a full line-up of products geared towards a multitude of tasks, no job is too big... or too small. All STANLEY® Power Cleaning Tools are built with practical features and useful accessories, and equipped with easy-to-operate powerful motors and double filtration systems for dry vacuum applications which provides optimum performance and clean exhaust air.

STANLEY® PRESSURE WASHER



ON-BOARD ACCESSORY STORAGE

Innovative storage for lance, gun, cable and hose

Transparent filter increases pump life whilst easy to clean



SPECIAL WATER INLET FILTER

STANLEY® VACUUM CLEANER



All latches are upgraded with better holding which is strongly secured to the main body of the vacuum chamber.



Every 8 gallons and above comes with blower port. The powerful blower port instantly converts vacuum to blower power.



All STANLEY® wet / dry vacuums are covered under a 1-year warranty



Top strong handles for easy transport.



Uniquely designed drain outlet promotes easy emptying.

**STANLEY® Vacuum Cleaner
Portable Series**

All latches **UPGRADED** for better holding. Strongly secured to the main body of the vacuum chamber.



- High performance motor provides maximum power
- Light weight compact design for easy carrying
- 6 - 10' power cord with cord wrap design for easy organization and storage
- Wall-mounted design for convenient storage

Accessories for 3 & 5 gallons include:
Flexible hose, three extension wands, crevice nozzle, floor brush, reusable dry filter, disposable filter bag



95-950

SKU#	DESCRIPTION	BOX/CTN
95-950	3 Gallons Portable Wet / Dry Vac	1/1
95-943	5 Gallons Stainless Steel Wet / Dry Vac	1/1

**STANLEY® Vacuum Cleaner
Portable Series**

- High performance motor provides maximum power
- Lightweight compact design for easy carrying
- Lower power cord with cord wrap design for easy organization and storage
- Wall-mounted design for convenient storage

Accessories for 1 & 2.5 gallons include:
Flexible hose, crevice nozzle, utility nozzle, reusable dry filter



95-947



95-949

SKU#	DESCRIPTION	BOX/CTN
95-947	Hangup 1 Gallon Plastic Wet / Dry Vac	1/1
95-949	Hangup 2.5 Gallons Plastic Wet / Dry Vac	1/1

**STANLEY® Vacuum Cleaner
Professional Series**

- High performance motor provides maximum power
- Light weight compact design for easy carrying
- 6 - 10' power cord with cord wrap design for easy organization and storage
- Wall mounted design for convenient storage

Accessories for 8 & 10 gallons include:
Flexible hose, three extension wands, crevice nozzle, floor brush, reusable dry filter, disposable filter bag.



95-944

SKU#	DESCRIPTION	BOX/CTN
95-944	8 Gallons Stainless Steel Wet / Dry Vac	1/1
95-945	10 Gallons Stainless Steel Wet / Dry Vac	1/1

**STANLEY® Vacuum Cleaner
Heavy-Duty Industrial Series**

- Powerful heavy-duty motor for industry leading performance provides maximum power of suction and blowing for heavy-duty pickup
- High efficiency particulate air filter treated with Microbion fights and inhibits the growth of mold, mildew and bacteria.
- Great for drywall dust, fine filtration, washable, reusable, use for both wet and dry pickups
- Strong handle for easy carrying
- Large on/off switch with waterproof design for safe & quick access
- 16' power cord with cord wrap design
- Heavy-duty rear wheels with swivelling front casters provide ease of movement in any direction
- On-board storage box keeps tools in order
- Easy-to-assemble removable steel handle for easy storage

Accessories for 16 gallons include:
Flexible hose, three extension wands, crevice nozzle, floor brush, reusable dry filter, disposable filter bag.



95-946

SKU#	DESCRIPTION	BOX/CTN
95-946	Heavy-duty 16 Gallons Stainless Steel Wet / Dry Vac	1/1

ACCESSORIES LIST

NO	SKU#	ITEM DESCRIPTION	95-947-23 1 Gal / 4L
1	97-526	Flexible Hose, 4" (95-947, 95-949)	•
2	97-527	Flexible Hose, 5" (95-950, 95-943)	
3	97-528	Flexible Hose, 6" (95-944, 95-945)	
4	97-529	Flexible Hose, 7" (95-946)	
5	97-530	Extension Wands, 3 pcs (95-947, 95-949, 95-950, 95-943)	•
6	97-531	Extension Wands, 2 pcs (95-944, 95-945)	
7	97-532	Extension Wands, 2 pcs (95-946)	
8	97-533	Crevice Nozzle (95-947, 95-949, 95-950, 95-943, 95-944, 95-945)	•
9	97-534	Crevice Nozzle (95-946)	
10	97-535	Utility Nozzle (95-947, 95-949, 95-950, 95-943, 95-944, 95-945)	•
11	97-536	Suction Latch (95-946)	
12	97-537	Floor Brush (95-947, 95-949, 95-950, 95-943, 95-944, 95-945)	•
13	97-538	Floor Brush (95-946)	
14	97-539	Wall-Mounted Bracket (95-946)	•
15	97-540	Reusable Dry Filter 1pc w/ Mounting Ring (95-947, 95-949, 95-950, 95-943)	•
16	97-541	Reusable Dry Filter, 3pcs w/o Mounting Ring (95-947, 95-949, 95-950, 95-943)	•
17	97-542	Foam Filter (95-947, 95-949, 95-950, 95-943)	•
18	97-543	Disposable Filter Bag (95-950)	
19	97-544	Disposable Filter Bag (95-943)	
20	97-545	Paper Dust Bag (95-944, 95-945)	
21	97-546	Paper Dust Bag (95-946)	
22	97-547	Cartridge/HEPA Filter (95-944, 95-945, 95-946)	

95-949-23 2.5 Gal / 10L	95-950-23 3 Gal / 11L	95-943-23 5 Gal / 19L	95-944-23 8 Gal / 30L	95-945-23 10 Gal / 40L	95-946-23 16 Gal / 60L
•					
	•	•			
			•	•	
					•
•	•	•			
			•	•	
					•
•	•	•	•	•	
					•
•	•	•	•	•	
					•
•					
•	•	•	•	•	
•	•	•			
	•				
		•			
			•	•	
					•
			•	•	•

**STANLEY® Pressure Washer
1400W**



STPW1400

- Unique on-board storage design for all accessories
- Powerful 1400W motor
- 100 Bar Max Pressure
- With handle & wheel for easy carrying
- Cast aluminum pump for improved durability
- Auto Stop System

Accessories for STPW1400 include:
5m high pressure hose, variable nozzle, rotating nozzle, soap bottle, quick connect adaptors



SKU#	POWER	VOLTAGE	MAX PRESSURE	MAX FLOW	MOTOR	AUTO SHUT OFF	WEIGHT (kg)	CABLE LENGTH m
STPW1400	1400W	220V – 240V 50/60Hz	100 Bar	Max 5.5 L/Min or 330 L/Hr	UNIVERSAL	YES	5.86	5

**STANLEY® Pressure Washer
1800W**



STPW1800

- Unique on-board storage design for all accessories
- Powerful 1800W motor
- 140 bar max pressure
- With handle & wheel for easy carrying
- Cast aluminum pump for improved durability Auto Stop System

Accessories for STPW1800 include:
5m high pressure hose, variable nozzle, rotating nozzle, fixed brush, soap bottle, quick connect adaptors



SKU#	POWER	VOLTAGE	MAX PRESSURE	MAX FLOW	MOTOR	AUTO SHUT OFF	WEIGHT (kg)	CABLE LENGTH m
STPW1800	1800W	220V – 240V 50/60Hz	140 Bar	Max 6.7 L/Min, 400 L/Hr	UNIVERSAL	YES	8.4	5

11 POWER TOOLS

ERGONOMIC DESIGN, EASE OF USE & DURABILITY

With the comprehensive range of STANLEY® Power Tools, you can always find the right tool for the job. STANLEY® Power Tools range includes drills, saws, planer and grinders which are jobsite tested not just to prove they drive results, but also that they can make the job easier. Switches, adjustments, shape, weight, torque and handles are all designed with the professional contractors in mind, which is why so many professional contractors choose STANLEY® Power Tools. We're confident you'll find the right tool with the power you need to do the job better.



DRILLING



METAL WORKING



CORDLESS



100MM SLIDE SMALL ANGLE GRINDER

DURABILITY

- Heavy-Duty Switch
- Ball Bearing Design

ERGONOMIC

Compact design for user comfort & convenience

ERGONOMIC

Rubber overmold for better handling

DURABILITY

Long-life Brushes

USER CONVENIENCE

Easy Access Brushes

HIGH PERFORMANCE

750W Powerful Motor

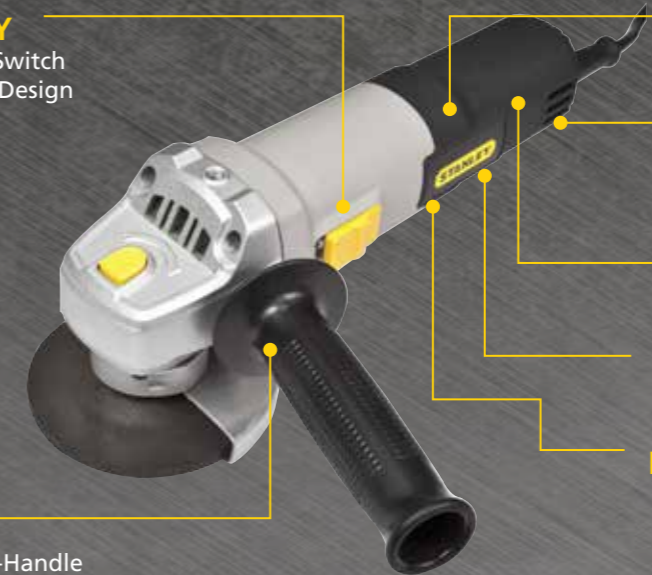

CONTROL

3-Position Side-Handle

STEL815

24MM 2 MODE SDS ROTARY HAMMER/HAMMER DRILL

HIGH PERFORMANCE

- 720W Powerful Motor
- Heavy Duty Chuck

USER CONVENIENCE

Lock-on

VERSATILITY

- 3 Mode Selector
- Rotary Drill
- Hammer Drill
- Chiselling

ERGONOMIC

Soft Grip for comfortable handling



STEL503K

355MM CHOP SAW

HIGH PERFORMANCE

High Torque Motor

COMFORT & CONTROL

Horizontal Handle

DURABILITY

- Long-life Brushes
- Ball Bearing Design
- Super Spring

DURABILITY

Heavy-Duty Guard

VERSATILITY

Mitre Adjustment

EASE OF USE

Quick Release Clamp

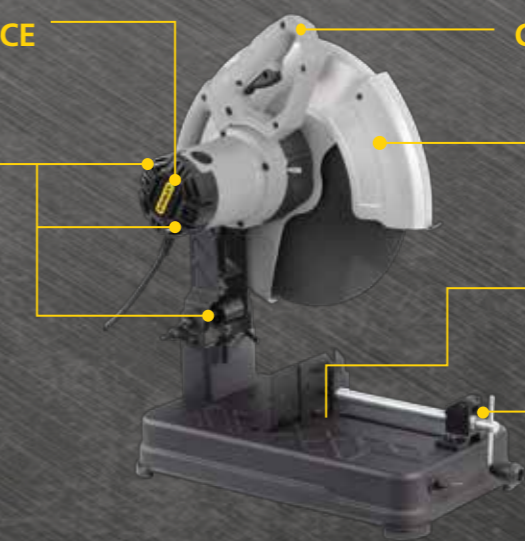

STEL701

METAL WORKING

100mm Slim Small Angle Grinder



STEL810

SKU#	POWER	NO LOAD SPEED	SWITCH TYPE	SPINDLE SIZE	CABLE LENGTH	NET WEIGHT	CARBON BRUSH PART NUMBER
STEL810	600W	11,000rpm	Slide	M10	2m	1.52kg	1004438-40

- FEATURES & BENEFITS**
- Slim design and light weight for increased comfort & control
 - External brush doors for easy access
 - Excellent value for end users

100mm Slide Small Angle Grinder



STEL811

SKU#	POWER	NO LOAD SPEED	SWITCH TYPE	SPINDLE SIZE	CABLE LENGTH	NET WEIGHT	CARBON BRUSH PART NUMBER
STEL811	610W	11,500rpm	Slide	M10	2m	1.5kg	1004683-57

- FEATURES & BENEFITS**
- Large diameter steelgears design for longer life
 - Simple brush change
 - Textured body design / Taper tail design to improve handling
 - Spindle lock for easy & quick accessory change

100mm Slide Small Angle Grinder



STEL815

SKU#	POWER	NO LOAD SPEED	SWITCH TYPE	SPINDLE SIZE	CABLE LENGTH	NET WEIGHT	CARBON BRUSH PART NUMBER
STEL815	750W	11,000rpm	Slide	M10	2m	1.7kg	1004525-38

- FEATURES & BENEFITS**
- Large diameter steelgears design for longer life
 - Textured body design
 - Taper tail design to improve handling
 - Three-position auxiliary handle for better comfort and handling

100mm Toggle Small Angle Grinder



STEL805

SKU#	POWER	NO LOAD SPEED	SWITCH TYPE	SPINDLE SIZE	CABLE LENGTH	NET WEIGHT	CARBON BRUSH PART NUMBER
STEL805	750W	11,000rpm	Toggle	M10	2m	1.7kg	1004525-38

- FEATURES & BENEFITS**
- Powerful motor for good performance
 - Great durability
 - Slim grip with toggle switch for comfortable use
 - Excellent value for end users

100mm Slide Small Angle Grinder



STEL812

SKU#	POWER	NO LOAD SPEED	SWITCH TYPE	SPINDLE SIZE	CABLE LENGTH	NET WEIGHT	CARBON BRUSH PART NUMBER
STEL812	900W	11,000rpm	Slide	M10	2m	2.1kg	1004557-26

- FEATURES & BENEFITS**
- Powerful motor - 900W for heavy-duty applications
 - Great durability
 - Comfortable with ergonomic design
 - Easy to use
 - Excellent value for end users

125mm Slide Small Angle Grinder



STEL816

SKU#	POWER	NO LOAD SPEED	SWITCH TYPE	SPINDLE SIZE	CABLE LENGTH	NET WEIGHT	CARBON BRUSH PART NUMBER
STEL816	750W	11,000rpm	Slide	M14	2m	1.87kg	1004525-38

- FEATURES & BENEFITS**
- Powerful motor for good performance
 - Comfortable with ergonomic design
 - Easy to use
 - Special air channels to optimize motor cooling for tool durability
 - Excellent value for end users

180mm Large Angle Grinder



STEL844

SKU#	POWER	NO LOAD SPEED	SWITCH TYPE	SPINDLE SIZE	CABLE LENGTH	NET WEIGHT	CARBON BRUSH PART NUMBER
STEL844	2,200W	8,400rpm	Trigger	M14	3m	5.4kg	1004684-37

- FEATURES & BENEFITS**
- High Performance Motor - 2200W
 - Increased ergonomics
 - Tool free safety guard for quick & easy adjustment
 - 3 position side handle for easy control and reduce user fatigue



STEL845

230mm Large Angle Grinder

SKU#	POWER	NO LOAD SPEED	SWITCH TYPE	SPINDLE SIZE	CABLE LENGTH	NET WEIGHT	CARBON BRUSH PART NUMBER
STEL845	2,200W	6,500rpm	Trigger	M14	3m	5.5kg	1004684-37

FEATURES & BENEFITS

- High performance motor - 2200w
- Increased ergonomics
- Tool free safety guard for quick & easy adjustment
- 3 position side handle for easy control and reduce user fatigue

Die Grinder



STEL861

SKU#	POWER	NO LOAD SPEED	CABLE LENGTH	CHUCK SIZE	CARBON BRUSH PART NUMBER
STEL861	500W	27,000rpm	Toggle	6mm	90593494

FEATURES & BENEFITS

- Rubber padded handle for comfortable handling
- Shuttered vents to prevent dust from entering
- Brush holder cap for easy brush change
- Forward air vent to lower temperature

355mm Chop Saw



STEL701

SKU#	POWER	NO LOAD SPEED	CARBON BRUSH PART NUMBER
STEL701	2,100W	3,800rpm	5170001-29

FEATURES & BENEFITS

- High performance with powerful 2,100W motor
- Easy and efficient wheel change with spindle lock
- Fast and secure material clamp with quick release mechanism

355mm Chop Saw



STEL705

SKU#	POWER	NO LOAD SPEED	CARBON BRUSH PART NUMBER
STEL705	2,300W	3,800rpm	5140063-05

FEATURES & BENEFITS

- Increased performance with powerful 2,300W motor
- Easy and efficient wheel change with spindle lock
- Fast and secure material clamp with quick release mechanism

DRILLING



STEL101

10mm Rotary Drill

SKU#	POWER	NO LOAD SPEED	SWITCH TYPE	REVERSE	STEEL	WOOD	CORD LENGTH	CARBON BRUSH PART NUMBER
STEL101	400W	0-2,700rpm	2- finger VSR	Yes	10mm	20mm	2m	90595071

FEATURES & BENEFITS

- Compact size enables easy drilling in all areas
- Increased ergonomics reduce the user fatigue
- 680W powerful motor can cover most of the applications
- Speed dial control for easy screw driving



STEL105

10mm Rotary Drill

SKU#	POWER	NO LOAD SPEED	SWITCH TYPE	REVERSE	STEEL	WOOD	CORD LENGTH	CARBON BRUSH PART NUMBER
STEL105	420W	0 - 3,000rpm	2- finger VSR	Yes	10mm	20mm	3m	673916-03

FEATURES & BENEFITS

- Cast aluminium and 420W Motor
- Ball bearing construction
- New ergonomic design - balanced for the professional user



STEL145

10mm Percussion Drill

SKU#	POWER	NO LOAD SPEED	SWITCH TYPE	REVERSE	STEEL	WOOD	MASONRY	CORD LENGTH	CARBON BRUSH PART NUMBER
STEL145	500W	0 - 3,000rpm	2- finger VSR	Yes	10mm	20mm	13mm	3m	673916-03

FEATURES & BENEFITS

- Cast aluminium and 500W Motor
- Ball bearing construction - smoother operation and longer life
- 2-Tools-in-1: Hammer Mode - for masonry work and drill mode for drilling and driving

10mm Percussion Drill With Kit Box & Acc



STEL141K

SKU#	POWER	NO LOAD SPEED	SWITCH TYPE	REVERSE	STEEL	WOOD	MASONRY	CORD LENGTH	CARBON BRUSH PART NUMBER
STEL141K	550W	0-2,800rpm	2- finger VSR	Yes	10mm	20mm	13mm	2m	90579768

FEATURES & BENEFITS

- 550W powerful motor for good performance
- Variable speed offers more control and is essential for driving screws
- Soft grip - more comfortable and ease of control
- Secondary handle to provide additional control

13mm Percussion Drill



STEL146

SKU#	POWER	NO LOAD SPEED	SWITCH TYPE	REVERSE	STEEL	WOOD	MASONRY	CORD LENGTH	CARBON BRUSH PART NUMBER
STEL146	620W	0 - 3,000rpm	2- finger VSR	Yes	13mm	25mm	16mm	3m	637916-03

FEATURES & BENEFITS

- High quality ball bearing and pre-cast aluminium design for longer life
- Both drilling and driving tools in 1
- "2 finger" variable speed control for ease of use

13mm Percussion Drill With Kit Box & Acc



STEL142K

SKU#	POWER	NO LOAD SPEED	SWITCH TYPE	REVERSE	STEEL	WOOD	MASONRY	CORD LENGTH	CARBON BRUSH PART NUMBER
STEL142K	650W	0 - 2,800rpm	2- finger VSR	Yes	13mm	25mm	16mm	2m	90579768

FEATURES & BENEFITS

- 650W powerful motor for good performance
- Variable speed offers more control and is essential for driving screws
- Soft grip - more comfortable and ease of control
- Secondary handle to provide additional control

CONCRETE WORKING

22mm 3-Mode Rotary Hammer/ Hammer Drill



STEL503K

SKU#	POWER	CHUCK	NO LOAD SPEED	BPM	IMPACT ENERGY	VSR	CABLE LENGTH	CARBON BRUSH PART NUMBER
STEL503	720W	22 mm	0 - 980rpm	0 - 5,200	2J	Yes	2m	90587066

FEATURES & BENEFITS

- 51 Chisel positions (3 modes) for maximum convenience
- 2J Impact energy for great power & performance
- Ergonomic design for comfort & control
- 3 Applications modes (Rotary Drill/Hammer Drill/Chiselling)
- Variable speed F/R switch max control

24mm 2-Mode SDS Rotary Hammer/Hammer Drill



STEL505K

SKU#	POWER	CHUCK	NO LOAD SPEED	BPM	IMPACT ENERGY	VSR	CABLE LENGTH	CARBON BRUSH PART NUMBER
STEL505K	750W	24mm	0 - 1,050rpm	0 - 5,000	2.7J	Yes	2.5m	1004518-50

FEATURES & BENEFITS

- 51 Chisel positions (3 modes) for maximum convenience
- 2.7J Impact energy for great power & performance
- Ergonomic design for comfort & control
- 3 Applications modes (Rotary Drill/Hammer Drill/Chiselling)
- Variable speed F/R switch max control

24mm 3-Mode Rotary Hammer/Hammer Drill



STEL506K

SKU#	POWER	CHUCK	NO LOAD SPEED	BPM	IMPACT ENERGY	VSR	CABLE LENGTH	CARBON BRUSH PART NUMBER
STEL506K	750W	24mm	0 - 1,050rpm	0 - 5,000	2.7J	Yes	2m	1004518-50

FEATURES & BENEFITS

- 51 Chisel positions (3 modes) for maximum convenience
- 2.7J Impact energy for great power & performance
- Ergonomic design for comfort & control
- 3 Applications modes (Rotary Drill/Hammer Drill/Chiselling)
- Variable speed F/R switch max control



STEL785

110mm Tile Cutter

SKU#	POWER	WHEEL DIAMETER	NO LOAD SPEED	MAX. CAPACITY	NET. WEIGHT	CABLE LENGTH	CARBON BRUSH PART NUMBER
STEL785	1,200W	110mm	13,000rpm	34mm	2.7kg	2m	90553946

FEATURES & BENEFITS

- High torque efficient motor increases performance & durability
- Ergonomic compact design for better user handling & ease of use
- Super extended brush life increases productivity

CORDLESS



STDC801NB

9.6V Cordless Drill, 2 Batt, 1.5 Hrs Charger

SKU#	VOLTAGE	CHUCK SIZE	NO LOAD SPEED	MAX TORQUE	CLUTCH SETTING	REVERSE	STEEL	WOOD
STDC801NB	9.6V	10mm	0 - 750rpm	10.4Nm	24	Yes	10mm	25mm

FEATURES & BENEFITS

- 24 torque clutch - for perfect screwdriving into a variety of materials with different screw sizes
- Spring loaded slide pack battery system for quick and easy battery change and a more secure fit
- Reverse switch for added versatility



STDC005NB

12V Cordless Drill/ Driver

SKU#	VOLTAGE	CHUCK SIZE	NO LOAD SPEED	MAX TORQUE	CLUTCH SETTING	REVERSE	STEEL	WOOD
STDC005NB	12V	10mm	0 - 3500 - 1,200rpm	21Nm	16	Yes	10mm	25mm

FEATURES & BENEFITS

- High performance motor for maximum power & durability
- Super compact & light weight design brings superior comfort & ease of use
- Variable speed & reverse with 2 speed gear-box ensures maximum control & performance



STDC001NB

12V Cordless Drill, 2 Batt, 1.5Hrs Charger

SKU#	VOLTAGE	CHUCK SIZE	NO LOAD SPEED	MAX TORQUE	CLUTCH SETTING	REVERSE	STEEL	WOOD
STDC001NB	12V	10mm	0 - 750rpm	11Nm	24	Yes	10mm	25mm

FEATURES & BENEFITS

- 24 torque clutch - for perfect screwdriving into a variety of materials with different screw sizes
- Spring loaded slide pack battery system for quick and easy battery change and a more secure fit
- Reverse switch for added versatility

1 MEASURING & LAYOUT TOOLS
 2 LASER MEASURING SYSTEM
 3 CUTTING & HOLDING TOOLS
 4 FASTENING TOOLS
 5 STRIKING & STUCK TOOLS
 6 ILLUMINATION TOOLS
 7 PAINTING & FINISHING TOOLS
 8 MECHANICAL TOOLS
 9 TOOLS STORAGE
 10 POWER CLEANING TOOLS
 11 POWER TOOLS
 12 POWER TOOL ACCESSORIES
 13 PRODUCT INDEX



STDC201NB

14.4V Cordless Drill, 2 Batt, 1.5 Hrs Charger

SKU#	VOLTAGE	CHUCK SIZE	NO LOAD SPEED	MAX TORQUE	CLUTCH SETTING	REVERSE	STEEL	WOOD
STDC201NB	14.4V	10mm	0 - 750rpm	12.1Nm	24	Yes	10mm	25mm

FEATURES & BENEFITS

- 24 torque clutch - for perfect screwdriving into a variety of materials with different screw sizes
- Spring loaded slide pack battery system for quick and easy battery change and a more secure fit
- Reverse switch for added versatility



STDC001LB

10.8V Li-ion Drill

SKU#	VOLTAGE	BATTERY AMP/HOUR	BATTERY TYPE	CHUCK SIZE	NO LOAD SPEED	MAX TORQUE	CLUTCH SETTING	RE-VERSE
STDC001LB	10.8V	1.3Ah	Lithium Ion	10mm	0 - 315 / 0 - 1,200rpm	27Nm	20	Yes

FEATURES & BENEFITS

- Compact size with high power
- Magnetic bit storage & belt clip
- Intelligent energy efficient fast charger
- Comfortable with ergonomic design
- Easy to use



STDC041LB

10.8V Li-ion Impact Drill

SKU#	VOLTAGE	BATTERY AMP/HOUR	BATTERY TYPE	CHUCK SIZE	NO LOAD SPEED	MAX TORQUE	REVERSE
STDC041LB	10.8V	1.3Ah	Lithium Ion	6.35mm	0 - 2,400 rpm	107Nm	Yes

FEATURES & BENEFITS

- Compact size with high power
- Anti-vibration, rubber padded handle improves handling, comfort & safety
- Belt hook for safety and prevents accidental drops
- Energy efficient & fast charging



STDC441LB

18V Impact Driver

SKU#	VOLTAGE	BATTERY AMP/HOUR	BATTERY TYPE	CHUCK SIZE	NO LOAD SPEED	MAX TORQUE	REVERSE
STDC441LB	18V	1.5Ah	Li-ion	6.35mm	0 - 2,800rpm	164Nm	Yes

FEATURES & BENEFITS

- VSR switch and Lock on
- Battery energy indicator
- 18V Lithium Battery
- Two bits holder for user convenience
- Two position belt hook



STDC130LA

10.8V Li-ion Recip Saw, 1 Batt, 1 Charger

SKU#	VOLTAGE	STROKES/ MIN	STROKE LENGTH	KEYLESS BLADE CLAMP	OBITAL ACTION	ADJUSTABLE SHOE	VARIABLE-SPEED TRIGGER
STDC130LA	10.8V	0-3,000spm	16mm	Yes	No	Yes	Yes

FEATURES & BENEFITS

- Reduces material vibration and allows for one handed use
- Could use as a traditional Reciprocating Saw or Jigsaw
- Charger will auto cut-off when battery is fully charged
- Delivers fast straight-cutting and controlled detail-cutting



STBT12L

Cordless 10.8V Battery & Charger

SKU#	DESCRIPTION	Voltage	Battery Type	Battery Capacity	Charging Time	Part Number
STBT12L	Battery	10.8V	*Comes with Blister Pack	Lithium-Ion 1.3Ah	-	-
	Charger	10.8V	* Available as spare part	Lithium-Ion	30 mins	90576992

* only available for STANLEY® 10.8V Li-Ion Power Tools

WOOD WORKING

Planer



STEL630

SKU#	POWER	VOLTAGE	DEPTH OF CUT (PLANER)	WIDTH OF CUT (PLANER)	SPEED	NO LOAD SPEED	REBATING DEPTH	CARBON BRUSH PART NUMBER
STEL630	750W	230V	0-2.0mm	82mm	Single	16,000rpm	12mm	1004526-16

FEATURES & BENEFITS

- Left & right dust extraction which can be used in any direction with effective dust extraction
- 12 Position dial at 0.2mm increments for increased accuracy
- Improved dust bag design for easy-fit and enhanced dust entrapment
- 3 Chamfer grooves to maximize versatility
- Increased rebate cut with 12mm maximum depth of cut

1/3 Sheet Sander



STEL421

SKU#	POWER	NO-LOAD OSCILLATIONS	NO LOAD ORBITS	CARBON BRUSH NUMBER
STEL421	210W	14,000 - 30,000/min	7,000 - 15,000/min	90579732

FEATURES & BENEFITS

- Compact design gets you closer to the work surface for greater control
- Variable speed for greater control when sanding
- Large orbit size and high sander speed for faster material removal
- Lightweight sander with front and rear handles for maximum comfort and control
- Quick & easy paper change - hook & loop or traditional clip attachment
- Ergonomic front handle allows for comfortable operation of the sander

1/4 Sheet Sander



STEL401

SKU#	POWER	NO-LOAD OSCILLATIONS	NO LOAD ORBITS	CARBON BRUSH NUMBER
STEL401	220W	32,000/min	16,000/min	90579705

FEATURES & BENEFITS

- Powerful 220W motor gets the job done quicker
- Compact design gets you closer to the work surface for greater control
- Large orbit size and high sander speed for faster material removal
- Palm grip design for single-handed sanding
- Quick & easy paper change - hook & loop or traditional clip attachment
- Large quality dust bag ensure less mess when sanding for clearer work area

Jigsaw



STEL345

SKU#	POWER	NO-LOAD OSCILLATIONS	STROKE LENGTH	WEIGHT	CABLE LENGTH	CARBON BRUSH PART NUMBER
STEL345	650W	3,200/min	20mm	2.7kg	3m	90554571

FEATURES & BENEFITS

- 650W motor delivers power in demanding applications
- 7 position speed dial (0- 3,200 SPM) provides multiple speed settings for optimal cutting results
- 4 Orbital settings provides best cutting performance in a variety of materials
- Tool free bevel adjustment at 0°, 15°, 30° and 45° makes bevel changes fast and easy
- Keyless blade change makes blade replacements fast and easy
- LED light provides greater visibility on the cutting surface
- Soft grip handle and front grip area provides greater control and comfort during use

1 MEASURING & LAYOUT TOOLS
 2 LASER MEASURING SYSTEM
 3 CUTTING & HOLDING TOOLS
 4 FASTENING TOOLS
 5 STRIKING & STUCK TOOLS
 6 ILLUMINATION TOOLS
 7 PAINTING & FINISHING TOOLS
 8 MECHANICAL TOOLS
 9 TOOLS STORAGE
 10 POWER TOOLS
 11 POWER TOOLS
 12 POWER TOOL ACCESSORIES
 13 PRODUCT INDEX

SAWS

Reciprocating Saw



STEL365

SKU#	POWER	STROKES/ MIN	STROKE LENGTH	KEYLESS BLADE CLAMP	ADJUSTABLE SPEED TRIGGER
STEL365	850W	0 - 3,200rpm	28.5mm	Yes	Yes

FEATURES & BENEFITS

- 850W powerful motor
- High quality switch
- Soft grip to deliver best comfort for end users
- Keyless blade clamp
- Adjustable material fence for various cutting applications

Circular Saw



STEL311

SKU#	POWER	NO LOAD SPEED	BLADE DIAMETER	DEPTH OF CUT	BEVEL CAPACITY
STEL311	1,510W	5,500rpm	185mm	62mm	45 Degrees

FEATURES & BENEFITS

- 1510W powerful motor
- Soft grip for comfortable handling
- Dust extraction lever
- Front of handle
- Retractable lower guard
- Quick release depth adjustment
- Steel-stamped shoe
- 0 - 45 degrees bevel

GENERAL APPLICATIONS

Heatgun



STEL670

SKU#	POWER	HEAT SETTING	SWITCH CONTROL	TEMPERATURE	AIR FLOW	CABLE LENGTH
STEL670	2,000W	Variable	2 Stages	50-450°C/ 90-600°C	300 litres per min/ 500 litres per min	3m

FEATURES & BENEFITS

- Spherical nozzle avoid accidental blockages during operations
- Versatility of application : Full variable temperature settings and two air flow stages
- Self-standing design for hands-free use

Blower



STEL680

SKU#	POWER	NO LOAD SPEED	AIR VOLUME	CORD LENGTH	CARBON BRUSH PART NUMBER
STEL680	600W	0 - 11,000rpm	3.5m³/min	3m	1004138-00

FEATURES & BENEFITS

- 600W powerful motor
- Variable speed control
- 2-tools-in-1: Blower and vacuum cleaner

12 POWER TOOL ACCESSORIES

PROFESSIONAL DESIGN, VERSATILITY & DURABILITY

Selecting the best drill bit, abrasive wheel or other professional power tool accessory to get the job done is as important as choosing the right power tool. STANLEY®'s product and engineering teams spend thousands of hours on jobsites during product design; testing the performance of our accessories. We rigorously test our products under demanding conditions and deliver innovative solutions that matter and measure up – accessories that work for you and your job.

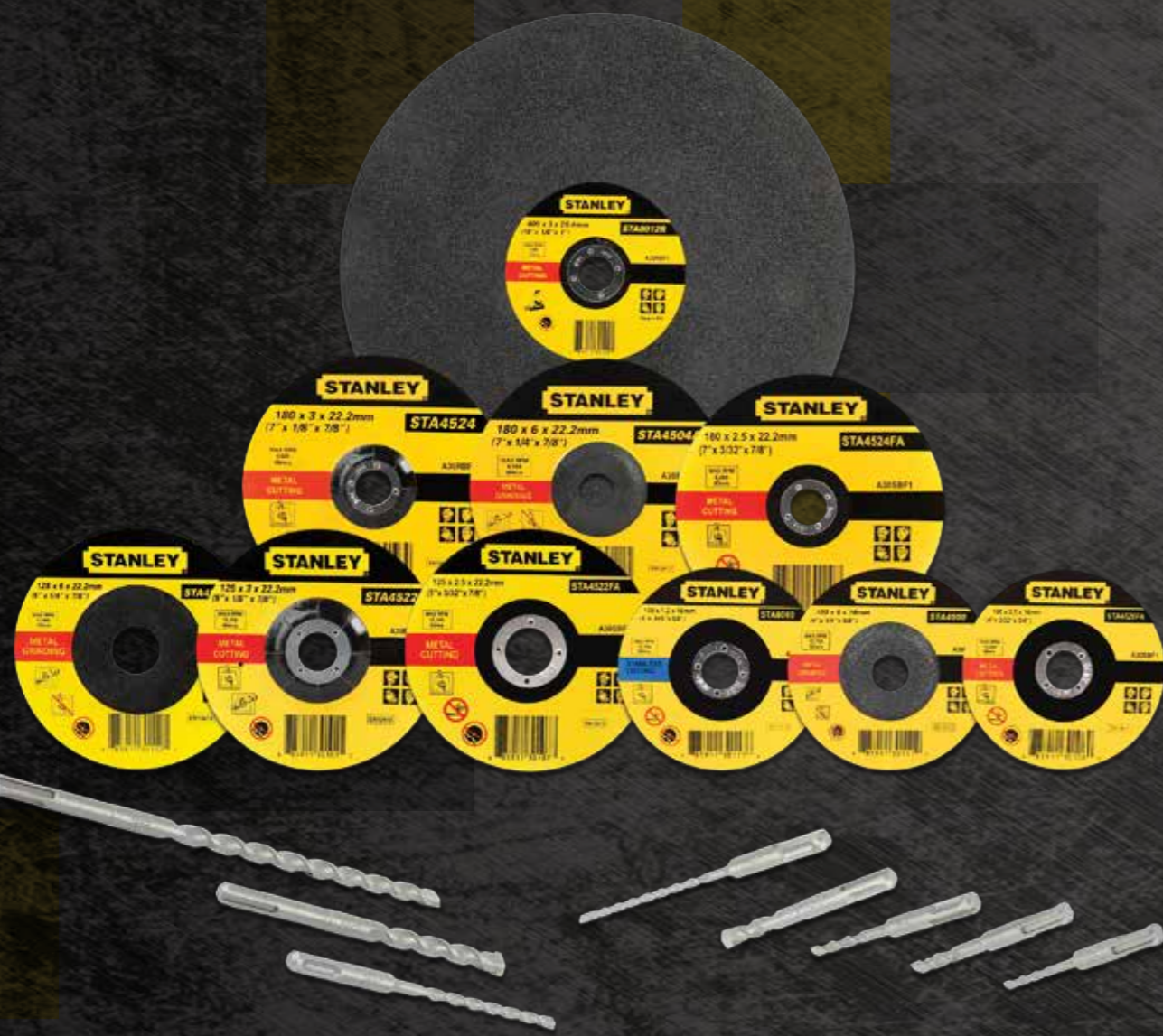

GRINDING WHEELS

KEY FEATURES

REINFORCED WITH 2.5 GLASS FIBRES THAT PROVIDE STRENGTH AND SAFETY

ROUGH ON GRINDING FACE WITH SHARP ABRASIVES

WELL BALANCED WHEEL

CONTROLLED DIMENSIONAL TOLERANCES

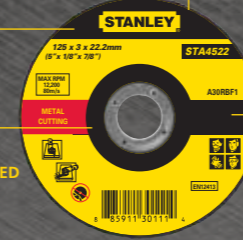

WIN WITH STANLEY

- Superior performance - 13% to 34% faster than competition
- Good wheel life
- Designed for safety
- Consistent quality
- Best suited for a variety of jobs

APPLICATIONS



STANLEY ABRASIVES GRIND FASTER BY 13% TO 34% PERFORMANCE CHART*

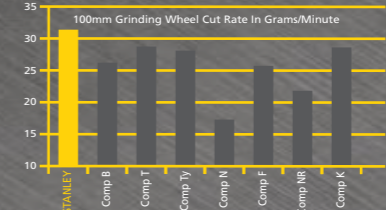

* Performance of Grinding Wheels was evaluated with an automated test rig on standard steel and grinding conditions.

CHOP SAW CUTTING WHEELS

KEY FEATURES

REINFORCEMENT OF GLASS FIBRE INCREASES STRENGTH AND PROVIDES WHEEL SAFETY

ROUGH GRINDING SURFACE WITH SHARP ABRASIVES

WELL BALANCED WHEEL

CONTROLLED DIMENSIONAL TOLERANCES



WIN WITH STANLEY

- Superior performance
- Longer life: 5% to 86% longer than competition
- Better cutting
- Designed for safety
- Consistent quality
- Best suited for a variety of jobs

APPLICATIONS



STANLEY CHOP SAW WHEELS LASTS LONGER BY 5% TO 86% PERFORMANCE CHART*

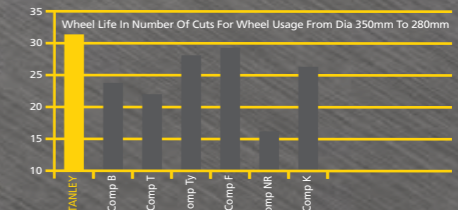

* Performance of Chop Saw Wheels was evaluated with an automated test rig on standard steel and cutting conditions.

SDS PLUS CARBIDE DRILL BITS

KEY FEATURES



SUPERIOR QUALITY OF CARBIDE

FLUTE DESIGNED FOR FASTER DRILLING

CONTROLLED DIMENSIONAL TOLERANCES

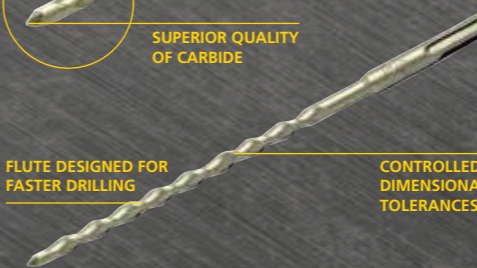

WIN WITH STANLEY

- Superior performance on hard concrete and bricks
- Longer life: 4.5% to 16% longer than competition
- Consistent quality

APPLICATIONS



STANLEY SDS PLUS CARBIDE DRILL BITS LASTS LONGER BY 4.5% TO 16% PERFORMANCE CHART*

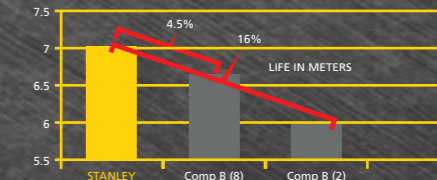

* Performance of Carbide Drill Bits was evaluated with an automated test rig on hard concrete and standard drilling conditions.

Grinding Wheels



STA4502A

SKU#	TYPE	DIAMETER mm	THICKNESS mm	BORE mm	GRADE	MAX RPM	UNITS PER PACK
STA4510	27	100	4	16	Metal	13,750	25
STA4500	27	100	6	16	Metal	13,750	25
STA4502A	27	125	6	22.2	Metal	11,000	25
STA4503A	27	150	6	22.2	Metal	10,100	10
STA4504A	27	180	6	22.2	Metal	8,500	10
STA4505A	27	230	6	22.2	Metal	6,600	10

- FEATURES & BENEFITS**
- Grinding of steel, iron plates, rebar & weld
 - Good grinding efficiency
 - High quality aluminum oxide grain
 - Reinforced fibreglass for high durability

Cutting Wheels



STA4524FA

SKU#	TYPE	DIAMETER mm	THICKNESS mm	BORE mm	GRADE	MAX RPM	UNITS PER PACK
STA8060	1	100	1.2	16	Stainless Steel	15,200	25
STA8050	1	100	1.6	16	Stainless Steel	15,200	25
STA4520FA	1	100	2.5	16	Metal	15,200	25
STA4522FA	1	125	2.5	22.2	Metal	12,200	25
STA4523FA	1	150	2.5	22.2	Metal	10,100	10
STA4524FA	1	180	2.5	22.2	Metal	8,500	10

- FEATURES & BENEFITS**
- Cutting of steel, iron plates, rebar & weld
 - Good cutting efficiency
 - High quality aluminum oxide grain
 - Reinforced fibreglass for high durability

Grinding/ Cutting Wheels



STA4522

SKU#	TYPE	DIAMETER mm	THICKNESS mm	BORE mm	GRADE	MAX RPM	UNITS PER PACK
STA4520	27	100	3	16	Metal	15,200	25
STA4522	27	125	3	22.2	Metal	12,200	25
STA4523	27	150	3	22.2	Metal	10,100	10
STA4524	27	180	3	22.2	Metal	8,500	10

- FEATURES & BENEFITS**
- Cutting & grinding of steel, iron plates, rebar & weld
 - Good cutting and grinding efficiency
 - High quality aluminum oxide grain
 - Reinforced fibreglass for high durability

Chop Saw Wheels



STA8011R

SKU#	TYPE	DIAMETER mm	THICKNESS mm	BORE mm	GRADE	MAX RPM	UNITS PER PACK
STA8011R	1	350	3	25.4	Metal	3875	10
STA8012R	1	400	3	25.4	Metal	3440	10

- FEATURES & BENEFITS**
- Cutting of steel, iron plates, rebar & weld
 - Good cutting efficiency
 - High quality aluminum oxide grain
 - Reinforced fibreglass for high durability

Circular Saw Blades (Wood)

- Tungsten carbide tips for longer life
- Thin kerf design for more efficient cuts
- Expansion slot for longer lasting blade due to cooler cutting
- For ripping and cross cutting of hard/soft wood, plywood
- Manufactured with Auto-grinding and Auto-welding processes



20-521

SKU#	DESCRIPTION	RPM	WEIGHT	BOX/CTN
20-521	Circular Saw Blade For Wood - 7 1/4" x 1" x 24T with 16 & 20mm Adaptor	7500	0.340	25/50
20-522	Circular Saw Blade For Wood - 7 1/4" x 1" x 40T with 16 & 20mm Adaptor	7500	0.340	25/50
20-523	Circular Saw Blade For Wood - 7 1/4" x 1" x 60T with 16 & 20mm Adaptor	7500	0.340	25/50
20-524	Circular Saw Blade For Wood - 8 1/4" x 1" x 40T with 16 & 20mm Adaptor	7000	0.420	25/50
20-525	Circular Saw Blade For Wood - 8 1/4" x 1" x 60T with 16 & 20mm Adaptor	7000	0.420	25/50
20-535	Circular Saw Blade For Wood - 10" x 1" x 40T with 16 & 20mm Adaptor	5500	0.800	25/25
20-536	Circular Saw Blade For Wood - 10" x 1" x 60T with 16 & 20mm Adaptor	5500	0.800	25/25
20-537	Circular Saw Blade For Wood - 12" x 1" x 100T with 16 & 20mm Adaptor	4500	1.250	20/20

Circular Saw Blades (Non-Ferrous)

- Tungsten carbide tips for longer life
- Thin kerf design for more efficient cuts
- Expansion slot for longer lasting blade due to cooler cutting
- For cutting of Aluminum, Copper, Lead, Zinc, Tin



20-538

SKU#	DESCRIPTION	RPM	WEIGHT	BOX/CTN
20-538	Circular Saw Blade For Aluminum - 10" x 1" x 100T with 16 & 20mm Adaptor	5500	0.800	25/25
20-539	Circular Saw Blade For Aluminum - 10" x 1" x 120T with 16 & 20mm Adaptor	5500	0.800	25/25

SDS Plus Hammer Carbide Drill Bits



SKU#	PRODUCT DESCRIPTION	DIAMETER mm	TOTAL LENGTH mm
STA54237-XJ	SDS Hammer	4	110
STA54002-XJ	SDS Hammer	5	110
STA54282-XJ	SDS Hammer	5	160
STA54007-XJ	SDS Hammer	5.5	110
STA54277-XJ	SDS Hammer	5.5	160
STA54012-XJ	SDS Hammer	6	110
STA54032-XJ	SDS Hammer	6	160
STA54312-XJ	SDS Hammer	6.5	110
STA54147-XJ	SDS Hammer	6.5	160
STA54152-XJ	SDS Hammer	7	160
STA54022-XJ	SDS Hammer	8	110
STA54037-XJ	SDS Hammer	8	160
STA54057-XJ	SDS Hammer	8	210
STA54317-XJ	SDS Hammer	8	260
STA54027-XJ	SDS Hammer	10	110
STA54042-XJ	SDS Hammer	10	160
STA54062-XJ	SDS Hammer	10	210
STA54207-XJ	SDS Hammer	10	260
STA54322-XJ	SDS Hammer	10	310
STA54047-XJ	SDS Hammer	12	160
STA54067-XJ	SDS Hammer	12	210

SKU#	PRODUCT DESCRIPTION	DIAMETER mm	TOTAL LENGTH mm
STA54097-XJ	SDS Hammer	12	260
STA54327-XJ	SDS Hammer	12	310
STA54122-XJ	SDS Hammer	12	450
STA54332-XJ	SDS Hammer	13	160
STA54337-XJ	SDS Hammer	13	260
STA54052-XJ	SDS Hammer	14	160
STA54072-XJ	SDS Hammer	14	210
STA54102-XJ	SDS Hammer	14	310
STA54077-XJ	SDS Hammer	16	210
STA54107-XJ	SDS Hammer	16	310
STA54127-XJ	SDS Hammer	16	450
STA54082-XJ	SDS Hammer	18	210
STA54112-XJ	SDS Hammer	18	310
STA54132-XJ	SDS Hammer	18	450
STA54087-XJ	SDS Hammer	20	210
STA54117-XJ	SDS Hammer	20	310
STA54137-XJ	SDS Hammer	20	450
STA54357-XJ	SDS Hammer	22	250
STA54217-XJ	SDS Hammer	22	450
STA54362-XJ	SDS Hammer	24	450
STA54367-XJ	SDS Hammer	25	250
STA54227-XJ	SDS Hammer	25	450

FEATURES & BENEFITS

- Drilling on hard concrete & bricks
- Long life
- Excellent durability